



UNIVERSIDAD NACIONAL AUTÓNOMA DE MÉXICO

INSTITUTO DE ENERGÍAS RENOVABLES

INSTITUTO DE INGENIERÍA

METHODOLOGY TO SIMULATE A COMPLEX  
BUILDING USING ENERGYPLUS: DETAILED  
CASE STUDY FOR BUILDING 3.1.

T E S I S

QUE PARA OPTAR POR EL GRADO DE:

**Ingeniera en Energías Renovables**

PRESENTA:

**Paloma Xchel Vázquez Dávila**

TUTOR:

Guillermo Barrios del Valle



**IER**

Instituto de Energías  
Renovables



**INSTITUTO  
DE INGENIERÍA  
UNAM**

Temixco, Morelos, 2019



Universidad Nacional  
Autónoma de México

Dirección General de Bibliotecas de la UNAM

**Biblioteca Central**



**UNAM – Dirección General de Bibliotecas**  
**Tesis Digitales**  
**Restricciones de uso**

**DERECHOS RESERVADOS ©**  
**PROHIBIDA SU REPRODUCCIÓN TOTAL O PARCIAL**

Todo el material contenido en esta tesis esta protegido por la Ley Federal del Derecho de Autor (LFDA) de los Estados Unidos Mexicanos (México).

El uso de imágenes, fragmentos de videos, y demás material que sea objeto de protección de los derechos de autor, será exclusivamente para fines educativos e informativos y deberá citar la fuente donde la obtuvo mencionando el autor o autores. Cualquier uso distinto como el lucro, reproducción, edición o modificación, será perseguido y sancionado por el respectivo titular de los Derechos de Autor.



# Acknowledgements

---

I want thank to my parents, who without their help this would have been more difficult. To my sisters, who have been an important support throughout these years. To my nieces, who every weekend gave me love and a smile to continue. A big thank to all of them.

To my friends, with whom I have spent important moments, letting us grow and enjoy.

To Guillermo Barrios, who taught, helped and motivated me from the first day of classes until complete this process.

To Architect Francisco Rojas, who provided and helped me in all about Building 3.1. To Miriam Cruz and Angel Aranda from the GEE, who helped me in some doubts. To Jesús Quiñones from the ESOLMET-IER, who provided meteorological data from the Renewable Energies Institute. To the project Demonstration buildings of bioclimatic design in warm sub-humid climate at the UNAM's Renewable Energy Institute (FES-2017-01-291600) sponsored by the Fund CONACYT - Secretariat of Energy- Energy Sustainability.

To my thesis committee Guadalupe Huelsz, Heidi Villafán, Patricio Valadés and Pablo Elías for taking the time to review this thesis and for all your comments that improved it.



---

## Abstract

Energy consumption on the building sector along the world is increasing, representing 40% of total energy consumption in all over the world. The use of whole building simulations models has been increasing in the latest years in order to help to evaluate energy consumption and thermal comfort. This thesis provides a methodology and considerations that help to perform a proper simulation and validation using EnergyPlus in a specific space without the use of air-conditioning systems. The building selected is Building 3.1 from the Renewable Energies Institute (IER-UNAM) and specifically the Thermosciences Laboratory. SketchUp with the OpenStudio plug-in was used to create the geometry of the building. The OpenStudio Application was used as an interface to EnergyPlus to set constructions, boundary conditions and thermal loads. EnergyPlus together with the EP-Launch and IDF-Editor were used to integrate the natural ventilation with the air flow network model for all thermal zones. The validation of the simulation model was made by the comparison of the simulated indoor air temperature with measured data. The validation period was during the summer holidays of 2018, from July 14th to 22nd, so none internal loads from people, lights and equipment were considered in any thermal zone. The infiltration was simulated with the windows closed and with natural ventilation in the double vented walls. All previous assumptions were included in the Base Case, which underestimated the measured temperature. Three more cases were considered: 10% and 20% of total power from electrical equipment connected and another case with 10% of total power from electrical equipment connected and an increase in the Air Mass Flow Coefficient When Opening is Closed. The results are presented with plots for qualitative comparison between measured and simulated temperatures. Two cases presented a good qualitative comparison, the 10% of electrical equipment

---

case and the case with 10% of total power from electrical equipment and an increase in the Air Mass Flow Coefficient When Opening is Closed. To select the best case a quantitative comparison using metrics found in the literature was done for three cases. The quantitative comparison indicated that the results obtained from the simulations of two cases had a good comparison between the measured air temperature, giving good results in all the metrics evaluated.



# Contents

---

<b>List of figures</b>	<b>ix</b>
<b>List of tables</b>	<b>xv</b>
<b>1 Introduction</b>	<b>1</b>
1.1 Building energy consumption . . . . .	1
1.2 Importance of building simulations . . . . .	3
1.3 Motivation . . . . .	3
<b>2 Simulation model</b>	<b>5</b>
2.1 EnergyPlus and OpenStudio software . . . . .	5
2.2 Characteristics of Building 3.1 . . . . .	6
2.3 Considerations and simplifications . . . . .	10
2.3.1 Boundary conditions . . . . .	11
2.3.2 Shading elements . . . . .	13
2.3.3 Materials and constructions . . . . .	15
2.3.4 Internal mass . . . . .	19
2.3.5 Loads . . . . .	21
2.3.6 Airflow network . . . . .	22
2.3.7 Schedules . . . . .	24
2.3.8 Space types . . . . .	24

## CONTENTS

---

<b>3</b>	<b>Simulation model validation</b>	<b>27</b>
3.1	EnergyPlus weather file . . . . .	27
3.2	Experimental measurements . . . . .	28
3.3	Validation . . . . .	32
3.3.1	Base Case . . . . .	32
3.3.2	Equipment Loads Cases . . . . .	33
3.3.3	Infiltration Case . . . . .	35
3.4	Metrics for model validation . . . . .	36
3.5	Methodology for building simulations . . . . .	41
<b>4</b>	<b>Conclusions</b>	<b>51</b>
<b>A</b>	<b>Materials, constructions and constructions sets</b>	<b>55</b>
A.1	Materials . . . . .	55
A.2	Constructions . . . . .	57
A.3	Construction set . . . . .	60
A.4	Materials and thermal properties of Building 3.1 . . . . .	61
<b>B</b>	<b>EnergyPlus weather file</b>	<b>63</b>
B.1	Weather Converter . . . . .	63
B.1.1	Definitions file . . . . .	64
B.1.2	CSV file . . . . .	69
B.2	EPW validation . . . . .	69
<b>C</b>	<b>Methodology flux diagram</b>	<b>75</b>
	<b>Bibliography</b>	<b>79</b>

# List of figures

---

2.1	Real building view. Backside perspective. . . . .	7
2.2	Real building view. Front side perspective. . . . .	8
2.3	Schematic top plane representation of Building 3.1 orientation and near constructions. Building 3.1 location and dimensions are represented by the black rectangle. . . . .	9
2.4	Cross-section view of the model of the double walls in south-west façade at Building 3.1. . . . .	10
2.5	SketchUp geometry south-west façade of Building 3.1. Pointing with red arrow the Thermosciences Lab. North direction in orange line. . . . .	11
2.6	SketchUp geometry north-east façade of Building 3.1. Thermosciences Lab in red rectangle. . . . .	12
2.7	SketchUp geometry of Thermosciences Lab and its boundary conditions. Figure <b>a</b> , shows the Lab front side and Figure <b>b</b> , shows the Lab back side. . . . .	13
2.8	Photograph of Building 3.1 eaves. . . . .	14
2.9	SketchUp geometry simplification of Building 3.1 eaves with an equivalent eave. . . . .	15
2.10	SketchUp geometry zoom of complex shading model at Building 3.1.	16

## LIST OF FIGURES

---

2.11 SketchUp geometry simplification of complex shading model from Building 3.1. . . . .	16
2.12 Photograph of the hill located at the north-east façade of the Building 3.1. . . . .	17
2.13 SketchUp geometry simplification of Building 3.1 hill model. . . .	17
2.14 Photograph of the stairs zone in Building 3.1. . . . .	18
2.15 SketchUp geometry stairs zone simplification model in Building 3.1.	18
2.16 SketchUp geometry simplification of photovoltaic system at Building 3.1 simulation model. . . . .	19
2.17 Photograph of photovoltaic system in Building 3.1. . . . .	19
2.18 Constructions tab at OpenStudio interface. Example of constructions considered to create a Construction set for 3.1 Building. . .	20
2.19 Binnacle used to know occupation schedules from each users of the Thermosciences Lab. . . . .	22
2.20 Results of infiltration simulated inside Thermosciences Lab (ACH).	23
2.21 Air changes per hour of the natural ventilation inside a vented double wall of the Thermosciences Lab story. . . . .	24
3.1 SketchUp geometry of Building 3.1 South-West view, in doted square position of Thermosciences laboratory. In orange line, the North direction. . . . .	29
3.2 SketchUp upper plan view of the Thermosciences laboratory. In orange line, the North direction. In green circle, the temperature sensor position inside the Lab. . . . .	30
3.3 Schematic connection for the temperature sensor. Micro-controller ESP8266 in black rectangle. Resistance in light brown cylinder. Temperature sensor in black cylinder. . . . .	31

3.4	Measured air temperature, in blue line. Outside air temperature, in orange line. . . . .	32
3.5	Comparison between measured air temperature in blue line and Base Case Zone Mean Air Temperature simulated in orange line. .	33
3.6	Air temperatures simulated and measured. Equipment Loads Cases in percentage of the total power from the electric equipment that was connected: E10 in green line, E20 in red line. Measured air temperatures ( $T_{i,exp}$ ) in blue line. Orange line represents simulated temperatures from the Base Case. . . . .	35
3.7	Comparison between temperatures simulated and measured. Measured air temperatures in blue line, Base Case in orange line, cases E10 and Infiltration in green and red lines, respectively. . . . .	36
3.8	Linear adjustment. The measured and Base Case air temperatures.	39
3.9	Zoom plot of the linear adjustment for simulated temperatures. In Figure <b>a</b> , the Base Case. In Figure <b>b</b> , E10 case. In Figure <b>c</b> , Infiltration case. . . . .	44
3.10	Daily $\Delta LT$ . Results, In blue and orange of E10 and Infiltration cases, respectively. . . . .	45
3.11	Zoom plot for simulated temperatures for July 14th <b>a</b> , 17th <b>b</b> , 20th <b>c</b> and 21st <b>c</b> . Experimental measurements in blue line. Infiltration case temperatures in red line. E10 case temperatures in green line. . . . .	46
3.12	The linear adjustment with change, for Base Case temperatures. .	47
3.13	The linear adjustment with change, for E10 temperatures. . . . .	48
3.14	The linear adjustment with change, for Infiltration Case temperatures. . . . .	49



## LIST OF FIGURES

---

A.1	OpenStudio Constructions tab, Materials sub-tab and thermal properties to be defined. . . . .	56
A.2	OpenStudio Add new object button in green circle with a plus symbol inside. . . . .	56
A.3	OpenStudio Constructions Sub-tab, layers in order from outside to inside. Materials "My Model" in right side. . . . .	59
A.4	OpenStudio Construction sets tab, Constructions defined by Surface type. . . . .	62
B.1	Weather converter interface. . . . .	64
B.2	Location fields description, its name and type that must be used in the heather of the Definition File. . . . .	66
B.3	Internal data elements names required for a EnergyPlus weather file. In first column are shown the short names used in .def file, in second column are presented the long name for each variable, third column shows the units used by the EPW and in fourth columns the character used by EnergyPlus. . . . .	71
B.4	Example of a .def file, include heather, Data elements and weather data format. . . . .	72
B.5	Site Outdoor Air Drybulb Temperature from the simulation and the Outdoor temperature from Esolmet. . . . .	73
B.6	Surface Outside Face Incident Solar Radiation Rate per Area from the simulation and Global radiation from Esolmet. . . . .	73
B.7	Site Direct Solar Radiation Rate per Area from the simulation and Outdoor direct radiation from Esolmet. . . . .	73
B.8	Environment Site Wind Speed from the simulation and Wind speed from Esolmet. . . . .	74

C.1 Methodology flux diagram. . . . .	77
C.2 Flowchart symbols. . . . .	78



# List of tables

---

2.1	Characteristics of columns, metal and wood. Columns are made of high density concrete (HDC). . . . .	21
3.1	Calibrator temperature and the corresponding averaged temperature for one ds18b20 sensor and the standard deviation of the temperature sensor. . . . .	31
3.2	Connected electric equipment inside the Lab. Amount, type and power from each equipment. . . . .	34
3.3	Metrics used to validate simulation mode and values results for each case. . . . .	40
3.4	Metrics used to validate simulation mode and values results for each case, with $m$ and $b$ updated, and named $m2$ and $b2$ . . . . .	41
A.1	Constructions, materials and its thermal properties for Building	
3.1.	Columns are made of high density concrete (HDC). . . . .	61



---

## Chapter 1

# Introduction

---

### 1.1 Building energy consumption

The International Energy Agency (IEA) reported for 2015, that the building sector used 40% of total energy consumption all over the world, more than the transport (31%) and the industry (28%) sectors [1]. In the last 40 years, the total energy consumption in the building sector has grown by 1.8% per year. Around 75% of the total energy used in the building sector belongs to the residential sector [2]. In Mexico, the total number of buildings has increased by 33% in the last 13 years [3], causing an increment in the energy demand.

During 2015 in Mexico, 73% of building energy consumption was found to be used in thermal energy conversion processes such as cooking, and heating or cooling places and water, the remaining 27% corresponds to electrical usages [3]. Important factors on electrical consumption are the efficiency of the equipment, amount of people and time spent at the place, use of air-conditioning systems and the envelope characteristics of the buildings.

The building envelope is defined as the parts comprising the primary thermal barrier between the inside and outside, the building envelope plays an important role on the thermal performance, natural illumination and ventilation [4]. One way to evaluate the thermal performance of the building envelope for buildings

## 1. INTRODUCTION

---

with HVAC systems (heating, ventilation, and air conditioning) is by measuring the energy consumption. For buildings without the use of HVAC systems, one way to evaluate the thermal performance of the building envelope is analysing the indoor air temperature or the user thermal comfort. The energy transmitted through the envelope affects the energy consumption and thermal comfort, therefore, the lower the energy consumption or the greater time in thermal comfort can be translated as a better thermal performance for a specific building.

The National Dwelling Commission (CONAVI) divides Mexican climates in ten representative categories: semi cold, semi cold-dry, semi cold-humid, tempered, tempered dry, tempered humid, hot dry, hot extreme dry, hot humid and hot semi-humid and this commission recommends to build according to the climate [5]. Corresponding with this classification, Temixco, Morelos has a semi-humid climate.

According to the National Energy Efficiency Monitoring Report for Mexico it has been found that the energy consumption by air-conditioning systems per square meter have had an increase in 33.4% between 2000 and 2015. There has been also an increase in the number of fans from 12.5 to 27 millions between 1992 and 2015 [3]. Also, in this document is presented that for the past 20 years, the number of air conditioning systems duplicated. This increment occurred mostly in the regions with hot dry, hot extreme dry, hot humid and hot semi-humid climates, where cooling is usual, with up to 36% of the use of energy consumption in buildings [3]. To attend implications of the high impact on this usage the regulatory organism of use of energy (CONUEE) together with other institutions, universities and enterprises created norms for energy efficiency for the envelope of buildings in the commercial and residential sector, NOM-008-ENER-2001 and NOM-020-ENER-2011 [6, 7], respectively. These norms aim to reduce heat gains through the envelope building with the purpose of rationalizing the use

of the energy of the cooling systems, using a independent time analysis [5]. Huelsz et al. explain the importance of a time dependent analysis of the heat transfer through the envelope building for a proper thermal performance evaluation on climates where solar radiation is significant and temperature swing is important [8]. Therefore, the reduction of energy for heating and cooling systems is a central element in the design of buildings. The use of bioclimatic design can help reduce energy consumption as well as can promote thermal comfort for users.

## **1.2 Importance of building simulations**

The use of whole building simulations models has been increasing in the latest years in the design and operation of low energy, high-performance buildings and the development of policies that reduce energy consumption and propitiate thermal comfort. Whole building energy simulation programs are defined as the use of computational mathematical models to represent the physical characteristics, control strategies and energy systems of a building, in design or in actual operation. The simulations calculations include building energy flows, ventilation, energy use, thermal comfort and indoor environmental quality indexes, the calculations may help to evaluate and compare design scenarios [9]. In addition, the current resurgence of passive and low energy building designs is supported by simulations in scenarios with no mechanical heating or cooling systems, where indoor temperatures are predicted variables [10].

## **1.3 Motivation**

This thesis is part of the project Demonstration buildings of bioclimatic design in warm subhumid climate at the Renewable Energy Institute (IER-UNAM), sponsored by the Fund CONACYT - Secretariat of Energy- Energy Sustainability-



## 1. INTRODUCTION

---

Collaboration Projects In Energy Efficiency - Cooperation with California University. One of the objectives in this project is to design with bioclimatic criteria a new building for the IER, applying different bioclimatic strategies and using low energy cooling systems. And as presented previously, the energy consumption on buildings along the world is increasing. In hot Mexican climates almost the 30% of the energy consumption is used to provide thermal comfort to the occupants [3]. Also the use of whole building simulations models has been increasing in the latest years [11] in order to help to anticipate the consumption of energy and thermal comfort problems. Calixto *et al.* [12] made a literature review of simulations using EnergyPlus, in which most of the articles reviewed had not reported a methodology to follow for simulations of real buildings. Calixto notice only eight studies of comparisons between simulations and experimental data which most of them are focused to solve a specific problem.

According to the previous information, the general objective of this thesis is to develop a methodology to simulate a complex building and give a guide to validate the simulation model in a specific space without the use of an air-conditioning system, using EnergyPlus. The specific objectives of this thesis are to supply considerations and simplifications that can help to simulate a whole building; to provide the main items to have a simulation base case; to furnish other considerations that can improve the simulation model validation and anticipate requirements that can be included in the IER's new building.

---

## Chapter 2

# Simulation model

---

This chapter presents a brief description of the software used to do the simulation model in Section 2.1, the characteristics of the Thermosciences Lab located in Building 3.1 and site where it is located are described in Section 2.2. Some considerations and simplifications in boundary conditions are explained in Section 2.3.

## 2.1 EnergyPlus and OpenStudio software

For the realization of the simulations in this thesis, the software chosen is EnergyPlus, its graphical interface OpenStudio and the plug-in for SketchUp. EnergyPlus and OpenStudio are explained in the next paragraphs.

EnergyPlus is a whole building energy simulation program that can be used to model the thermal behaviour and energy consumption (heating, cooling, ventilation, lighting and water use) in buildings. The main characteristic is that EnergyPlus solves the heat transfer through the envelope elements using a time-dependent heat transfer model in one dimension. An advantage of EnergyPlus is that this software is free, it is open source and multi-platform, so it can be executed on Windows, Mac OS and Linux operating systems. Some of its main capabilities are that can do simultaneous simulations of thermal zones, the soft-

ware can make and give reports of the heat and mass transfer between thermal zones and the environment conditions with time steps defined by the user.

EnergyPlus can read input files and writes output variables to text files, these labours are done with two principal utilities: the IDF-Editor which handles the input files using a simple interface similar to a spreadsheet, and the EP-Launch which manages the input file and weather file and also provides access to output files generated by EnergyPlus with a simple interface.

OpenStudio is a graphical user-friendly interface that was developed by the same EnergyPlus creators, the National Renewable Energy Lab (NREL) and the Lawrence Berkeley National Lab [13]. It is also open source and multi-platform and is considered as a fully featured graphical interface that supports many of the options of the whole building energy modelling using EnergyPlus including HVAC systems. It is also possible to perform advanced daylight analysis using Radiance.

The OpenStudio SketchUp plug-in is an extension to SketchUp 3D modelling tool that allows to create the geometries needed for EnergyPlus. In addition, this extension, together with SketchUp allows to import geometries created in other software, such as AutoCad.

### **2.2 Characteristics of Building 3.1**

The case of study is the Thermosciences Lab, located in the story 2 of Building 3.1. This building has four stories and is located at the IER-UNAM in Temixco, Morelos, Mexico. In Figure 2.1 is presented a photograph of the Building 3.1, in its backside perspective and in Figure 2.2 its front side perspective. Temixco is a small city with high solar radiation levels and a hot semi-humid climate. The land where Building 3.1 was constructed has a non-uniform terrain with a little

hill in the north-east façade causing shade in the first two levels during some hours in the morning.

The Building 3.1 has a rectangular base of 10 m x 51 m, with large façades to the North and South with an angle of  $35^\circ$  to the East-West. According to this orientation, the largest façades are receiving radiation in the morning and in the afternoon, as can be seen in Figure 2.3.



**Figure 2.1:** Real building view. Backside perspective.

One of the main characteristics of this building is the use of double walls in the south-west side, as a bioclimatic strategy. This strategy aims to reduce the heat transfer through the walls during the afternoon. There are two different types of double walls: vented and non vented, it can be seen in the backside perspective in Figure 2.1, where the vented double walls are under the windows and the non vented above the windows. In Figure 2.4 the schematic cross-section view of the double walls is presented. The vented double walls have two openings with insect screen protection, where the openings are represented by the dotted line. The Building 3.1 also has horizontal solar protections to avoid direct solar radiation inside the spaces along the year.

## 2. SIMULATION MODEL

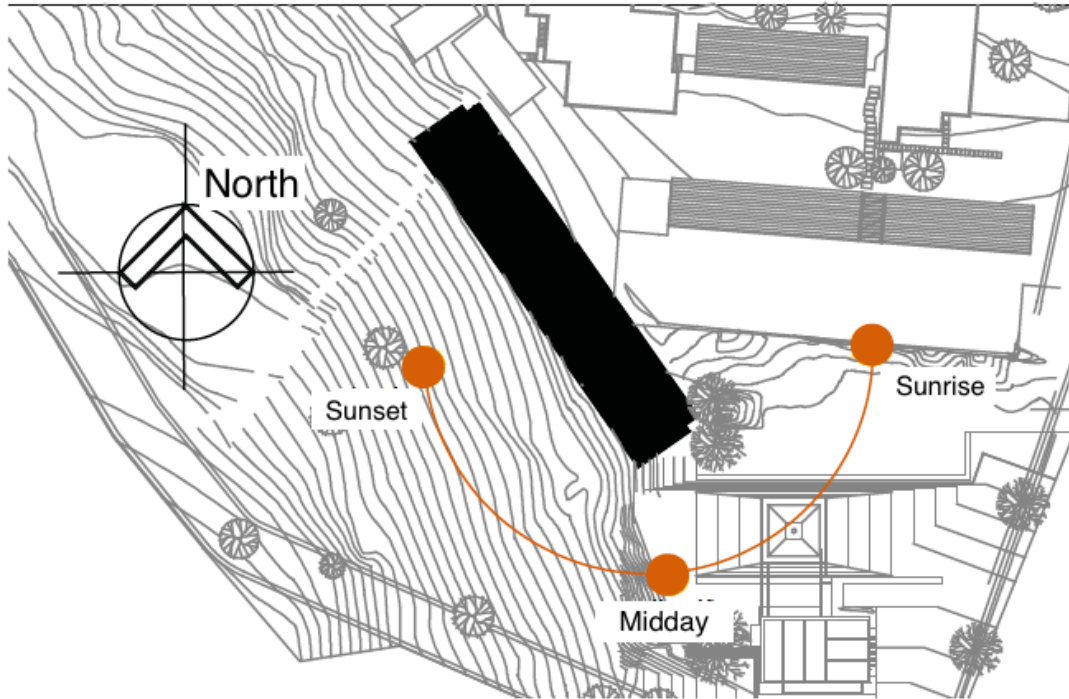
---



**Figure 2.2:** Real building view. Front side perspective.

The Building 3.1 has 4 stories with different uses: laboratories, offices, meeting rooms, and computer rooms. The Thermosciences Lab was selected to be used for the validation, so it was the only space where the indoor air temperature was measured. It is located in the second story, next to a meeting room (LIFYCS), above the Photovoltaic Lab and under two other Labs (Calorimetrics and Solar Concentration). All spaces have intermittent occupancy and uses are non-scheduled.

In Figure 2.5, the SketchUp geometry using the OpenStudio plug-in of the south-west façade of the Building 3.1 simulation model is presented. The red arrow indicates the site of the Thermosciences Lab, the orange line shows the north direction. In Figure 2.6 the north-east façade is shown. In this figure the

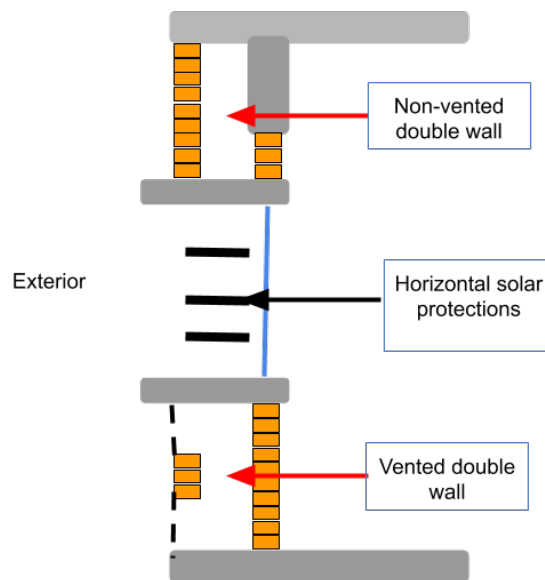


**Figure 2.3:** Schematic top plane representation of Building 3.1 orientation and near constructions. Building 3.1 location and dimensions are represented by the black rectangle.

red rectangle locates the Thermosciences Lab. This Lab has one vented double wall under windows and one non vented double wall above windows, marked in the red rectangle 2.6.

Building 3.1 was considered a complex building, owing to the fact that all the thermal zones of the right side of the building (facing it by the principal entrance), which were 27 in total, including 5 vented and 4 non vented double walls, were included. In each of the surfaces, boundary conditions were included, matching every surface with its corresponding adjacent surface. As well in the simulation model, all the solar protections and the shading elements into and near the building (such as photovoltaic system and a hill), were considered. All the spaces were simulated with each constructions and internal mass. Also, in all



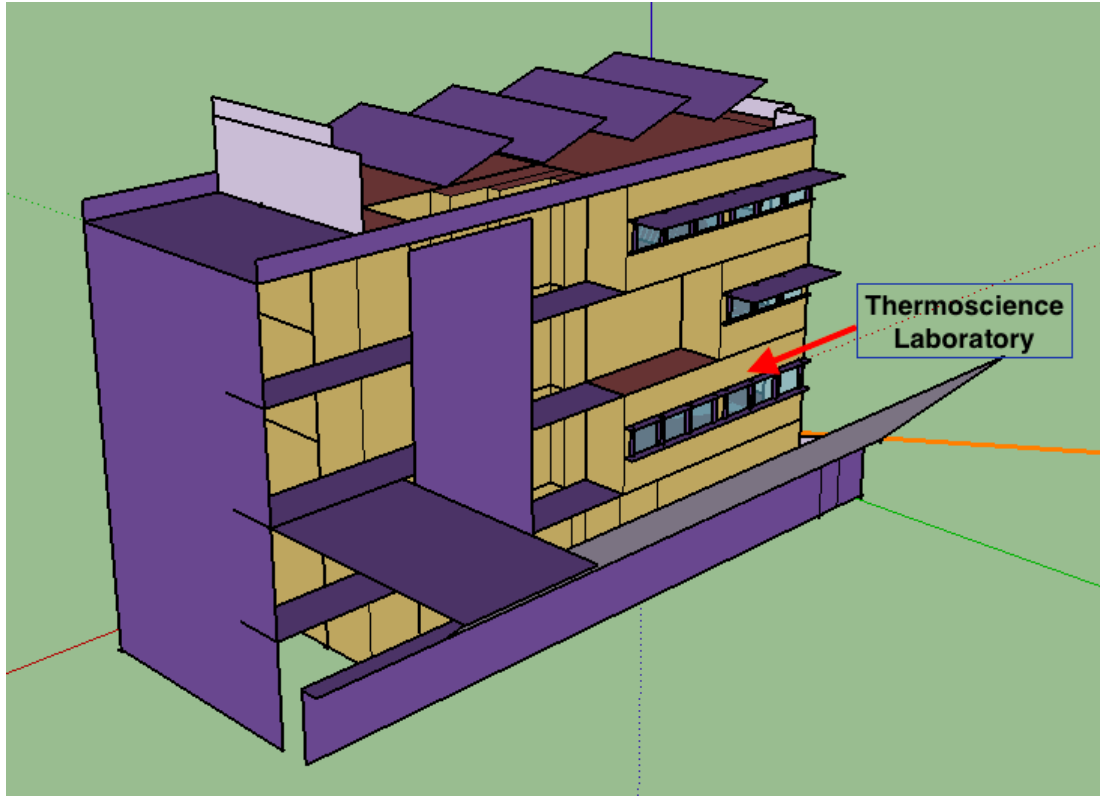


**Figure 2.4:** Cross-section view of the model of the double walls in south-west façade at Building 3.1.

of the spaces where was needed, infiltration or natural ventilation was included. It is known, that the simulation model is a theoretical approach to the reality, so in the following section, the all the considerations taken to represents the real building, are deeply explained.

### 2.3 Considerations and simplifications

In this section, the considerations and simplifications assumed to model the Thermosciences Lab inside Building 3.1 as a complex building are explained. Some of the considerations are applied using the plug-in for OpenStudio in SketchUp, in



**Figure 2.5:** SketchUp geometry south-west façade of Building 3.1. Pointing with red arrow the Thermosciences Lab. North direction in orange line.

OpenStudio App or at the EnergyPlus IDF Editor.

The first simplification was to draw only the right side of Building 3.1, facing it from the main entrance, as can be seen from Fig. 2.5. This is valid because the stair zone decouples the thermal zones from one side to the other.

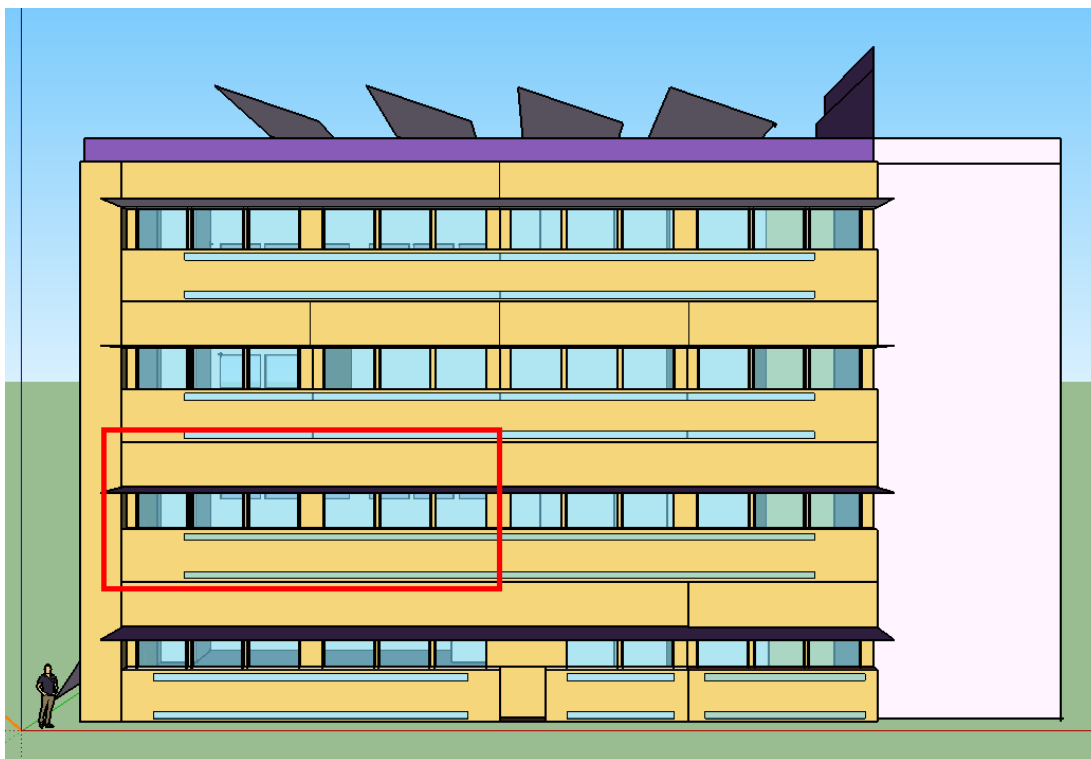
### 2.3.1 Boundary conditions

Boundary conditions are important to simulate correctly the heat transfer in the building. When a building is draw in SketchUp, the default boundary condition is Outdoors with sun and wind exposure. This means that surfaces with this boundary condition take into account the heat transfer by convection and radia-



## 2. SIMULATION MODEL

---

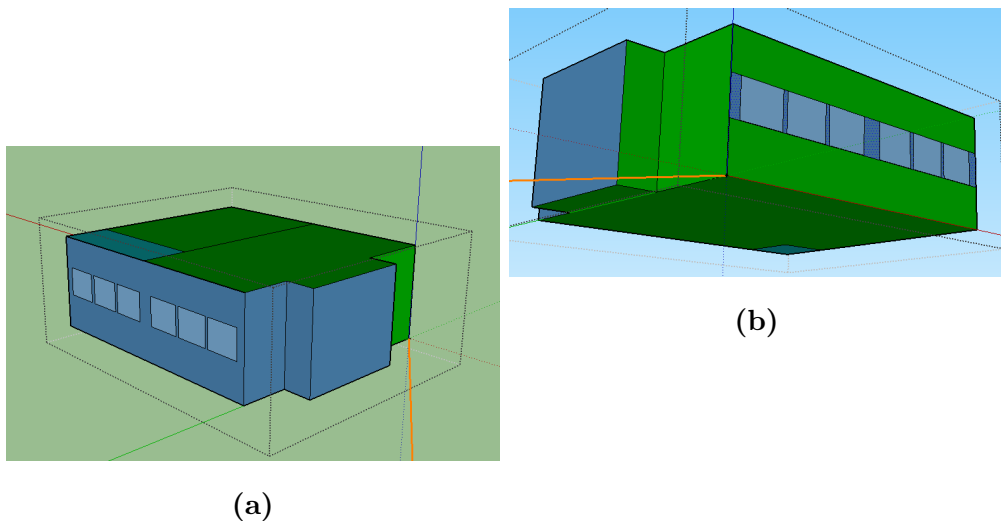


**Figure 2.6:** SketchUp geometry north-east façade of Building 3.1. Thermosciences Lab in red rectangle.

tion. Another default boundary condition applied is Ground. All ground surfaces have a boundary condition of temperature, defined by the user. A temperature of  $24\text{ }^{\circ}\text{C}$  was set for the simulation, taken from the program Climate consultant. One boundary condition that is not applied by default is the Surface boundary condition. This boundary condition indicates that the heat transfer between two adjacent surfaces with the same area flows from one thermal zone to another. This boundary condition was set to all corresponding surfaces using the inspector tool, matching each surface with its corresponding adjacent surface. Each level has a space destined for the electric boards and a cleaning room, both of them were not considered as thermal zones because they have a small thermal mass and no occupancy, so those spaces were simulated with surfaces with a boundary

condition of Outdoors with wind exposure and no sun exposure.

In Figure 2.7, some boundary conditions of Thermosciences Lab are presented. In green color the Surface boundary condition is applied, in blue color the Outdoors boundary condition is applied. Figure **a**, presents the front side of the Lab. Over the Lab, Surface boundary condition with two laboratories, was applied. Figure **b**, presents the back side of the Lab. Surface boundary condition with the vented and non vented double walls (under and above the windows, respectively), was applied. Under the Lab, Surface boundary condition with another laboratory was applied.



**Figure 2.7:** SketchUp geometry of Thermosciences Lab and its boundary conditions. Figure **a**, shows the Lab front side and Figure **b**, shows the Lab back side.

### 2.3.2 Shading elements

The following simplifications on shading elements were implemented with the OpenStudio SketchUp plug-in:

## 2. SIMULATION MODEL

---

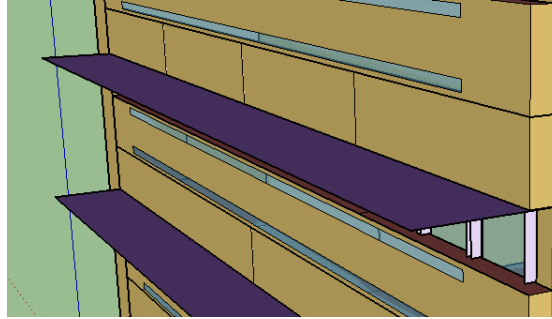
- Equivalent eave instead of multiple eaves, shown in Figures 2.8 and 2.9.
- Equivalent shading element with a transmittance instead of a complex shading elements, shown in Figures 2.10 and 2.11.
- Equivalent shading surface instead of the little hill in the north-east façade, as shown in Figures 2.12 and 2.13.
- Equivalent shading surfaces instead of stairs, shown in Figures 2.14 and 2.15.
- Equivalent shading surface instead of photovoltaic systems, as shown in Figures 2.16 and 2.17.

This simplifications reduces the computing time and it is easier to draw the complete building than the real one. Figure 2.9 shows an example of the simplifications of the eaves for a window, in it were considered the solar protection angles (azimuthal and zenith) of the multiple eaves.



**Figure 2.8:** Photograph of Building 3.1 eaves.

The complex shading system, presented in Figure 2.10 generated a shadow overlap warning in the simulation. This warning has been observed from several users and reported in the UnmetHours forum [14] and also in the energy-plus.helpserve.com [15]. Both places explain that “It may be safe to ignore these warnings, but it is hard to know for sure”. In order to avoid this warning, the complex shading system was replaced by a single shading surface with an equivalent



**Figure 2.9:** SketchUp geometry simplification of Building 3.1 eaves with an equivalent eave.

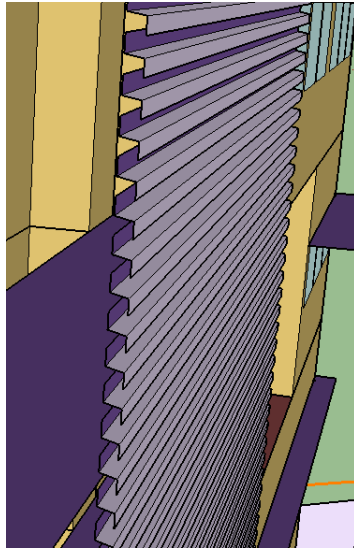
transmittance, the transmittance average for the validation period was considered. To calculate the equivalent transmittance values, in order to represent correctly the shade of the complex shading system, the complex shading system was drawn and simulated in a simple geometry and the average transmittance was calculated. The numerical experiment resulted in an equivalent transmittance of 0.48. This value was used for the transmittance of the single shading surface. The simplification of the complex shading is presented in Figure 2.11.

### 2.3.3 Materials and constructions

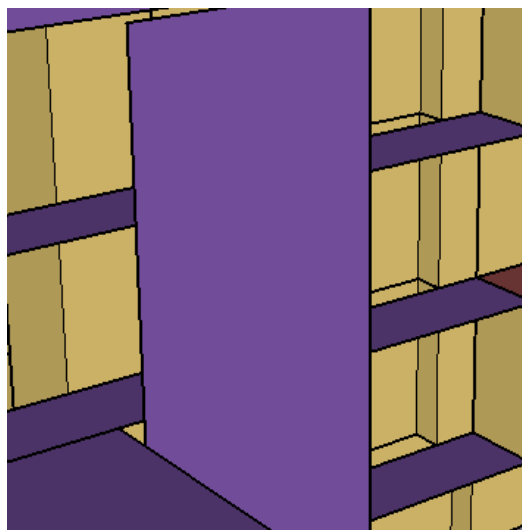
The materials that have been used for the simulation model were taken from the list of materials provided by the Technical Secretary from IER-UNAM. In the same way the constructions were obtained from the architectural plans of the building. The simulation model of Building 3.1 has five constructions. In the following paragraphs all constructions from exterior to interior are described and for each material the thermal properties in the Appendix A are specified. The floor of the first story, with ground contact, is composed of 10 cm of high density concrete and 1.5 cm ceramic tile. Outdoor walls are composed of 15 cm mortar

## 2. SIMULATION MODEL

---



**Figure 2.10:** SketchUp geometry zoom of complex shading model at Building 3.1.

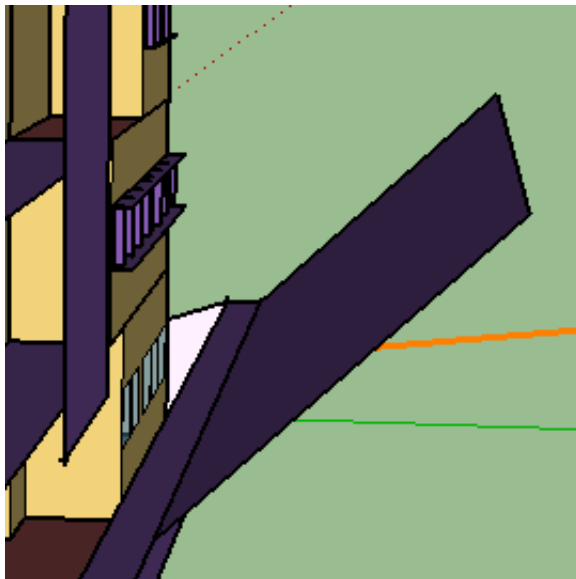


**Figure 2.11:** SketchUp geometry simplification of complex shading model from Building 3.1.

plaster of cement and sand, 12cm of red brick and another 1.5cm mortar plaster of cement and sand. Interior walls are composed of 1.9 cm of gypsum, wall air space with a resistance of  $0.18 \text{ m}^2\text{K}/\text{W}$  and 1.9 cm of gypsum. The interior



**Figure 2.12:** Photograph of the hill located at the north-east façade of the Building 3.1.



**Figure 2.13:** SketchUp geometry simplification of Building 3.1 hill model.

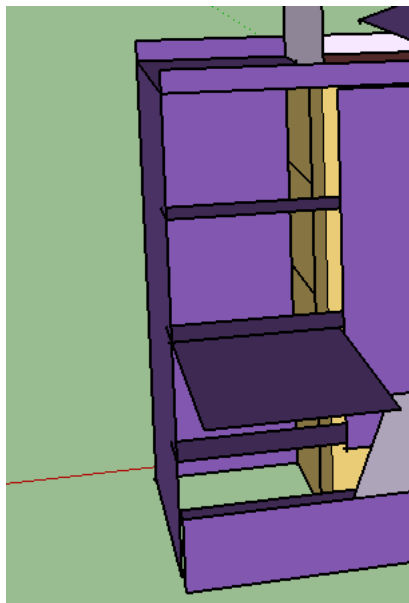
floors are composed of 1.5 cm ceramic tile and 12 cm of high density concrete. The interior ceilings are composed of 12 cm of high density concrete. All windows are composed of clear glass with 0.3 cm of thickness.

## 2. SIMULATION MODEL

---

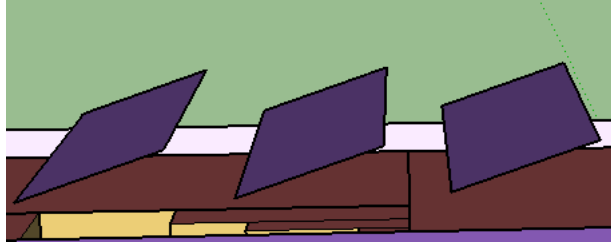


**Figure 2.14:** Photograph of the stairs zone in Building 3.1.



**Figure 2.15:** SketchUp geometry stairs zone simplification model in Building 3.1.

The Thermosciences Lab has three windows with curtains, so in the IDF-Editor a shading control object was assigned to those windows with the thermal properties taken from the InputOutput Reference, Windows shade materials sec-



**Figure 2.16:** SketchUp geometry simplification of photovoltaic system at Building 3.1 simulation model.



**Figure 2.17:** Photograph of photovoltaic system in Building 3.1.

tion [16]. The curtains were simulated with a solar transmittance of 0.1 and 0.8 solar reflectance in the interior. A construction set was created in OpenStudio to automate the assignation of constructions to each surface or subsurface type, as shown in Figure 2.18.

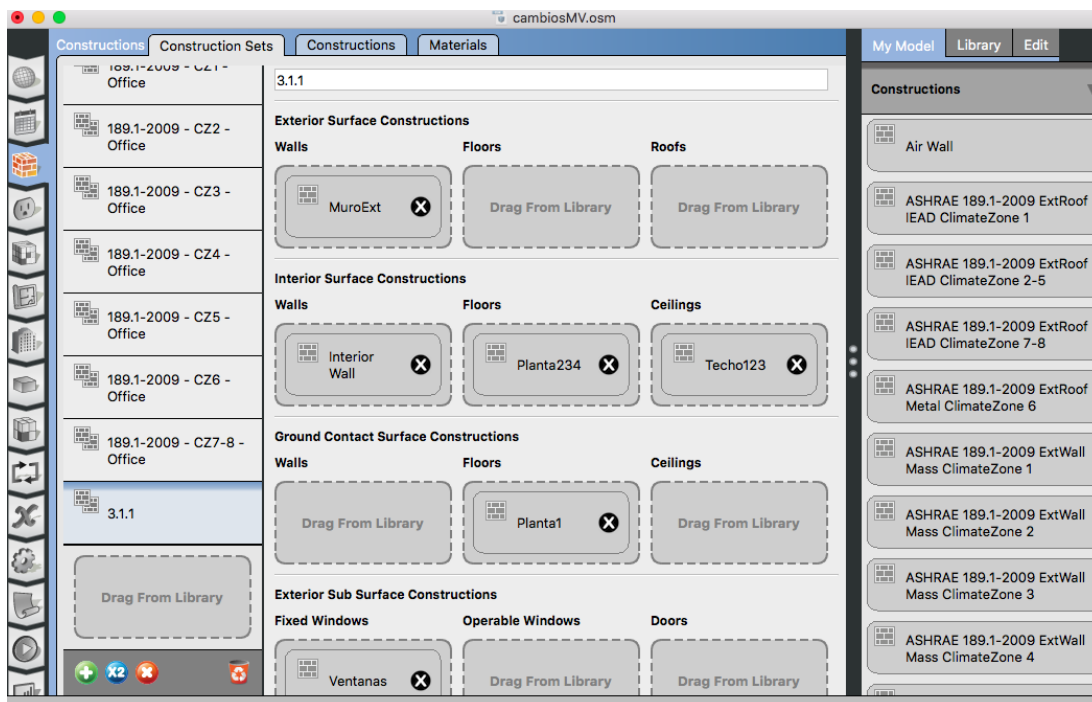
In appendix A it is explained with detail how to add new materials, constructions and constructions sets in OpenStudio and how to applied them to the simulation model.

### 2.3.4 Internal mass

The Input Output Reference [17] explains that any internal surface could be described as internal mass, such as interior wall, floor, ceiling or furniture and columns. The internal mass in EnergyPlus is defined inside a thermal zone with an object where a construction and area are assigned by the user.



## 2. SIMULATION MODEL



**Figure 2.18:** Constructions tab at OpenStudio interface. Example of constructions considered to create a Construction set for 3.1 Building.

There are two approaches to include internal mass. The first, is to have many constructions of internal mass. The other approach is to calculate and assign an equivalent construction into a one internal mass. In the Internal Mass Case (IM) the first approach was carried out. The IM case takes into account columns, metal and wood furnitures, each one, in a construction. In Table 2.1, it is shown the internal mass characteristics for columns, metal and wood furnitures. The high density concrete (HDC) thermal properties used in columns was taken from Ener-Habitat [18]. The thermal properties of metal decking and wood were taken from OpenStudio database. All thermal properties of the materials used for internal mass in the Appendix A, are specified. The volume for the columns was calculated using the columns in the Thermosciences Lab. The volume for the metal was measured from the metal tables inside the Thermosciences Lab and

the volume for the wood was calculated from the wood tables.

Internal mass was simulated with the internal mass from the Table 2.1 and was assigned to each space with proportion to the Thermosciences Lab.

Internal mass	Material	Thickness ( $m$ )	Area ( $m^2$ )	Volume ( $m^3$ )
Columns	HDC	0.20	0.9	0.36
Metal	Metal decking	0.001	33.0	0.033
Wood	Wood	0.025	10.0	0.25

**Table 2.1:** Characteristics of columns, metal and wood. Columns are made of high density concrete (HDC).

### 2.3.5 Loads

In order to be certain in the thermal loads of the Lab during the measurement period, a binnacle to all the Thermosciences Lab users was given before the holidays period. The binnacle used is presented in Figure 2.19, users filled daily with information about their occupation schedules inside the Laboratory in its corresponding row. It was also contemplated that guests could register their occupancy. In the binnacle there was an additional sheet, users should register the electrical equipment used. When none of the users filled out the binnacle, was assumed that there was no one in the Lab.

OpenStudio defines different types of loads that can be assigned, such as people, equipment of lights, electric, gas, water and steam, and internal mass. For the simulation period, was chosen a summer holiday period in which the users had not filled the binnacle, so the thermal loads from users were not considered, neither the use of electrical equipment and lights.

## 2. SIMULATION MODEL

---

Horarios Laboratorio Termociencias. Edificio 3.1													
Fecha:													
	8:00	9:00	10:00	11:00	12:00	13:00	14:00	15:00	16:00	17:00	18:00	19:00	20:00
Enrico Castro													
Alejandro Terán													
Denise Estrada													
Guillermo Ramírez													
J. Enrique Pérez													
Roberto Domínguez													
José C. Domínguez													
Salvador Guerrero													
Jazael Gómez													
Jonathan Sayago													
Invitado 1													
Invitado 2													
Invitado 3													

**Figure 2.19:** Binnacle used to know occupation schedules from each users of the Thermosciences Lab.

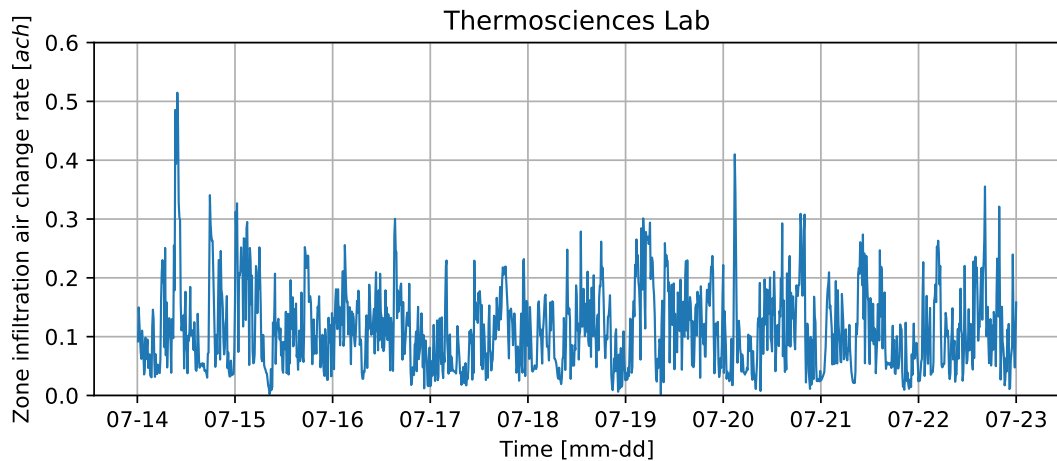
### 2.3.6 Airflow network

Natural ventilation and infiltration were simulated in EnergyPlus using the Airflow network (AFN) model. This model provides the ability to simulate an air distribution system, including supply and return leaks, and calculate multizone airflows driven by outdoor wind and forced air.

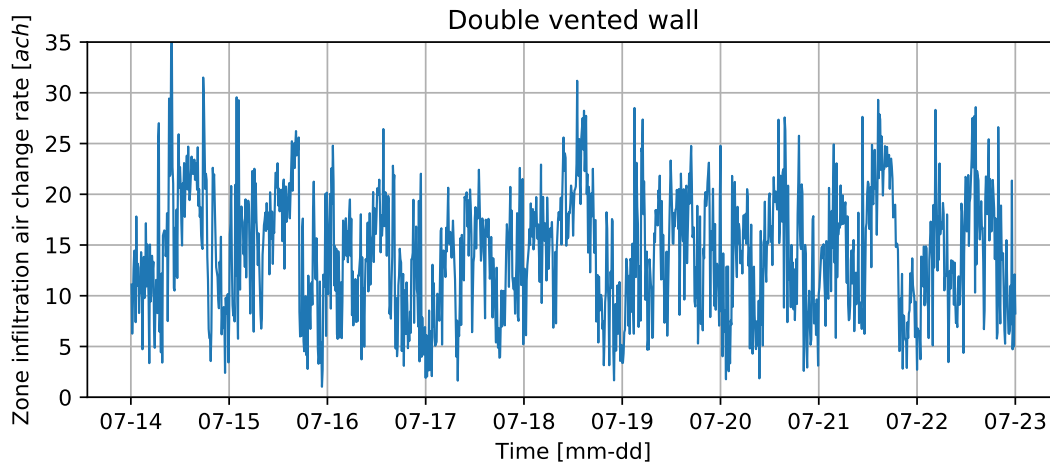
The infiltration inside all laboratories spaces was simulated with a value of 0.0001  $kg/s$  for the variable “Air Mass Flow Coefficient When Opening is Closed” for all windows, as recommended by [19, 20]. For the double vented walls, the discharge coefficient was set to 0.3 for the natural ventilation, corre-

sponding to a study that evaluates discharge coefficients on windows with insect-proof screens [21], this coefficient indicates the fractional effectiveness for air flow through a window or door. In all openings, the “Advanced Single Sided Wind Pressure Coefficient Algorithm” was used, which calculates the wind pressure coefficients for each opening. This coefficient is important because it influences the amount of infiltration that will enter to the zone, so it depends on the direction and speed of the wind, the height of the openings, the temperature of the outside air and the zone air temperatures. It is important to mention that this method it is only valid for surfaces with two openings, both in a single façade. Also, it was verified for the double vented walls, the mass conservation for each time step.

Air changes per hour (ach) simulated for the Thermosciences Lab and for the double vented walls are presented in Figures 2.20 and 2.21, respectively. As can be seen, the ach for the Thermosciences Lab is around 0.2 with maxima of 0.5, while the double vented wall ach maxima is higher than 30.



**Figure 2.20:** Results of infiltration simulated inside Thermosciences Lab (ACH).



**Figure 2.21:** Air changes per hour of the natural ventilation inside a vented double wall of the Thermosciences Lab story.

### 2.3.7 Schedules

EnergyPlus schedules allows users to program items such as occupancy, lighting, HVAC systems, and control shading elements on the simulation. The following schedules were considered for the simulation:

- Shading control of transmittance and reflectance for three curtains in the windows of the Thermosciences Laboratory always on.
- Electric equipment always off.

### 2.3.8 Space types

In OpenStudio, space types help the user to define construction sets, schedule sets, internal loads and infiltration for each space type assigned. Defining a space type avoids to drag each construction, loads and schedules to each object giving specific characteristics to each space type. The simulation model of Building 3.1 has the following space types:

- Laboratories.
- Vented double wall.
- Non-vented double wall.

Laboratories space type is defined with non thermal loads due to electrical equipment, users and lights. This space type has infiltration in all openings, calculated using the AFN, as described in Section 2.3.6 . Vented double walls space type has no internal load of any kind and includes natural ventilation as described in Section 2.3.6. Finally non-vented double wall space type was defined with no internal loads and without natural ventilation or infiltration. The three space types share the same building construction set, previously described in Section 2.3.3.

All the considerations and simplifications described in this chapter define the Base Case of the simulation model for the Thermosciences Lab in Building 3.1.



---

## Chapter 3

# Simulation model validation

---

In this chapter, the comparison of the simulation model of the Thermosciences Lab in Building 3.1 for the Base Case and three more cases are presented. In Section 3.1, the construction of the EnergyPlus weather file is presented. In Section 3.2, the sensor used to measure the air temperature inside the Lab, the calibration of the sensor and their placement inside the Lab are described. In Section 3.3, the validation period for the simulation model and four cases are specified, their results with a qualitative comparison between air temperature measured and simulated cases are presented. Finally the metrics and the comparison for the validation are presented in Section 3.4.

### **3.1 EnergyPlus weather file**

For the validation of the simulation model, an EnergyPlus weather file (EPW) was made with data from the Esolmet weather station [22]. The data used was: horizontal global solar radiation, normal direct solar radiation, dry bulb temperature, relative humidity, barometric pressure, rain precipitation, wind speed and wind direction. The EPW has six data per hour (every ten minutes). The data used from the Esolmet correspond from the 1st to the 31st of July. In appendix B, the process to made the EPW file is described.



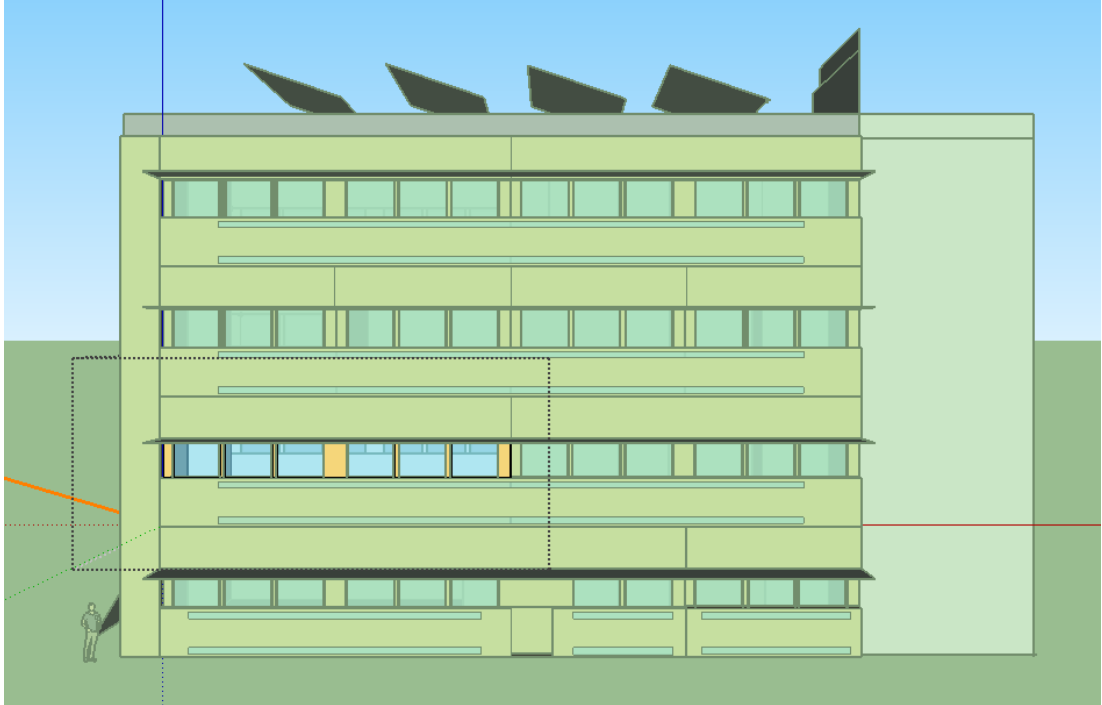
Once the EPW file is constructed, it is recommended to verify the data, in order to verify the weather file was correctly made, in Appendix B the validation of the EPW is explained.

## 3.2 Experimental measurements

The measurement period was during the summer holidays from June 29th to July 31st, 2018 in the Thermosciences Lab. The indoor air dry bulb temperature was measured inside the Lab, in the following it is simply named temperature. In Figure 3.1, the Thermosciences Lab position in dotted square and the orange line in the left of the Figure sets the North, are presented. In Figure 3.2, it can be seen the position where the sensor was located. This location was selected because it is the most central place with a close electrical connection. Also the temperature sensor was not near a heat source or did not receive direct solar radiation and was located 1.10 m above the ground.

The temperature sensor ds18b20 is a digital thermometer that provides temperature measurements from  $-55^{\circ}C$  to  $125^{\circ}C$  with an accuracy of  $0.5^{\circ}C$  from  $-10^{\circ}C$  to  $85^{\circ}C$ . The ds18b20 was installed with an ESP8266 micro-controller and MicroPython. The ESP8266 has integrated Wi-Fi, a compact design with few need of external circuits. The ESP8266 was programmed to read the value of the instantaneous temperature every 20 seconds and send the data to an Internet of Things (IOT) platform, where the information was stored and the user could download it at any time. Once downloaded the data had to be post processed to resample data every 10 minutes, to match with the output information given from EnergyPlus. In this resample, the instant temperature value every 10 minutes was used, in the following this resample is presented as  $T_{i\_exp}$ .

In Figure 3.3, it can be seen the schematic connection for the temperature



**Figure 3.1:** SketchUp geometry of Building 3.1 South-West view, in dotted square position of Thermosciences laboratory. In orange line, the North direction.

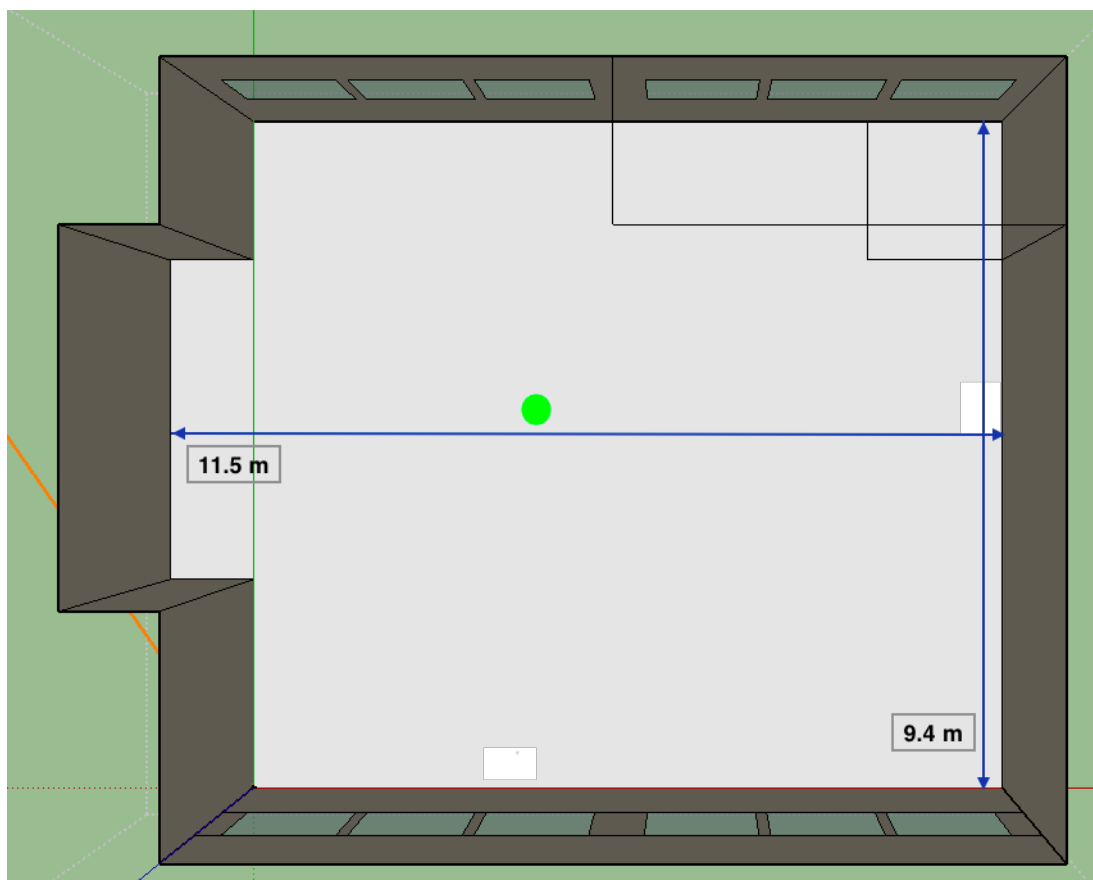
sensor ds18b20 and the ESP8266. The circuit, installed on a breadboard, has the D4 port connected (green wire) in parallel with the power supply (red wire) with a resistance of  $2.7\text{ k}\Omega$  and the ground connection (black wire). The ESP8266 is powered by a micro-USB cable.

The temperature sensor was calibrated with a Jofra-Ametek temperature calibrator with a precision of  $0.02^\circ\text{C}$ . Temperature values from  $10^\circ\text{C}$  to  $40^\circ\text{C}$  with steps of  $5^\circ\text{C}$  were measured every 20 seconds over 5 minutes. Table 3.1 presents the temperature results of the calibration. In the first column the temperature inside the calibrator is presented. The second column shows the average temperature of the ds18b20 sensor and in the third column the standard deviation of the measurements.

With temperature values of Table 3.1, a plot was made and a linear regression

### 3. SIMULATION MODEL VALIDATION

---



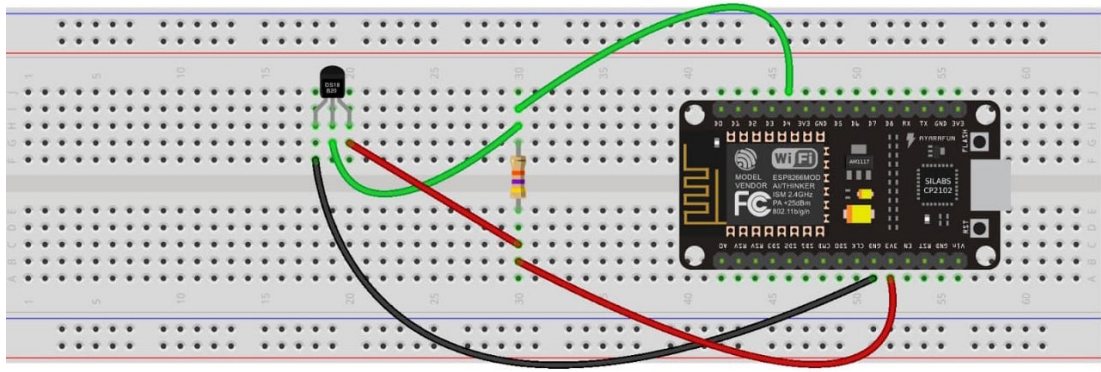
**Figure 3.2:** SketchUp upper plan view of the Thermosciences laboratory. In orange line, the North direction. In green circle, the temperature sensor position inside the Lab.

equation was obtained using the calibrator temperature and the mean sensor temperature. The calibration of the sensor is done with equation,

$$Ti = 0.9754T + 0.5755 \quad (3.1)$$

where  $T$  is temperature calibrated value given a measured value  $Ti$  and with a value of  $R^2 = 0.99$ . In the following, all temperature values reported are calibrated values.

The temperature sensor placed in the Lab stopped working, from 12th to



**Figure 3.3:** Schematic connection for the temperature sensor. Micro-controller ESP8266 in black rectangle. Resistance in light brown cylinder. Temperature sensor in black cylinder.

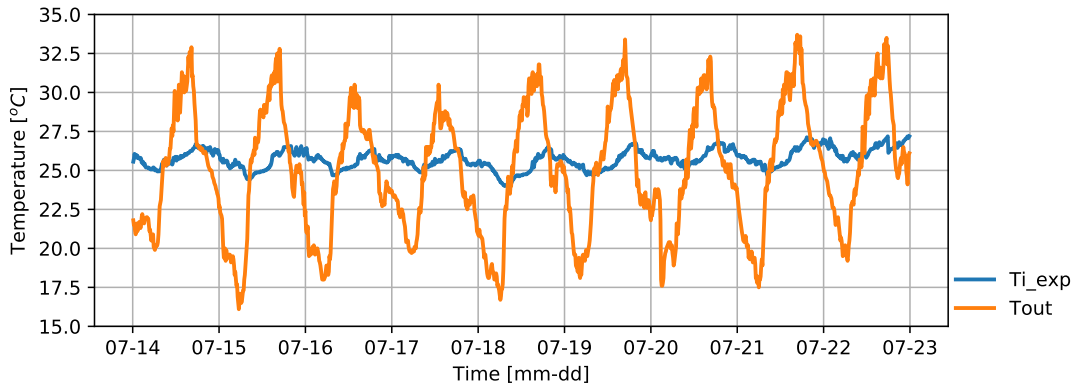
Calibrator temperature ( $^{\circ}C$ )	Mean sensor temperature ( $^{\circ}C$ )	Standard deviation ( $^{\circ}C$ )
10	10.38	0.31
15	15.13	0.36
20	20.14	0.35
25	25.06	0.04
30	29.62	0.19
35	34.67	0.02
40	39.72	0.11

**Table 3.1:** Calibrator temperature and the corresponding averaged temperature for one ds18b20 sensor and the standard deviation of the temperature sensor.

13th of July, so it was defined as the validation period from 14th to 22nd of July. Figure 3.4 presents the measured air temperature,  $T_{i\_exp}$ , and the outside air temperature,  $T_{out}$ .

### 3. SIMULATION MODEL VALIDATION

---



**Figure 3.4:** Measured air temperature, in blue line. Outside air temperature, in orange line.

## 3.3 Validation

In this section a comparison from July 14th to 22nd, between measured air temperature and simulated results from four cases are presented. Measured air temperature  $T_{i\_exp}$  is the temperature sensor during this nine days. The simulations use the EPW file made with data from 1st to 31st of July.

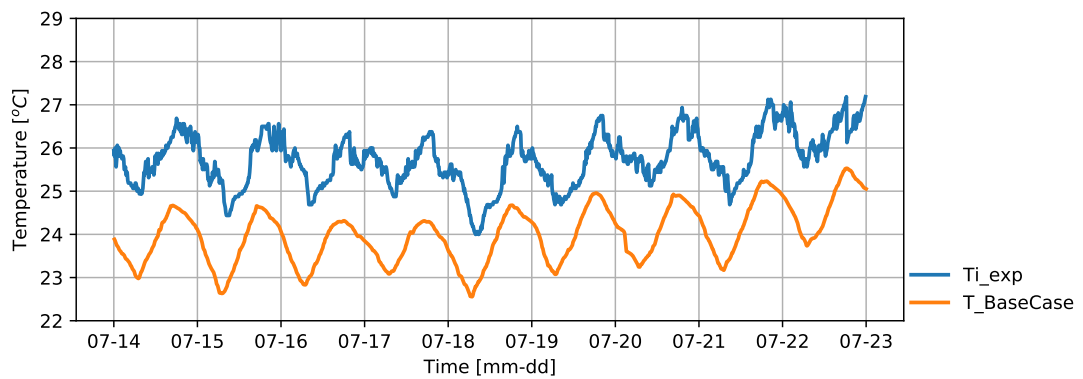
### 3.3.1 Base Case

The Base Case is constituted with all the assumptions presented in Section 2.3.

Some of the considerations are:

- Internal mass in spaces.
- No people and no lights.
- Natural ventilation for vented double walls using the Airflow network.
- No internal loads from equipment in any space.
- Infiltration in all spaces using the Airflow network.

The simulated temperature for the Thermosciences Lab during the validation period for the Base Case,  $T_{\text{BaseCase}}$ , and the measured air temperature,  $T_{\text{exp}}$ , are presented in Figure 3.5. It can be seen that  $T_{\text{exp}}$  is higher than the simulated temperature  $T_{\text{BaseCase}}$  but they exhibit similar behaviour. The difference between the  $T_{\text{exp}}$  and  $T_{\text{BaseCase}}$  is up to 2 °C but with a similar amplitude in the temperature oscillation.



**Figure 3.5:** Comparison between measured air temperature in blue line and Base Case Zone Mean Air Temperature simulated in orange line.

As it was observed in the simulated temperatures of the Base Case, there is a heat source that was not contemplated, so another case was proposed to approach the experimental temperatures.

### 3.3.2 Equipment Loads Cases

In this subsection, the loads due to equipment are included. Although the validation period was in a holiday season with no users and was not reported the use of electric equipment inside the Thermosciences Lab. In the Equipment Loads Cases was considered that the equipment can consume 10% or up to 20 % of energy consumption when they are off but still connected [23]. Therefore, an inventory was made of all electrical equipment inside the Thermosciences Lab.

### 3. SIMULATION MODEL VALIDATION

---

In Table 3.2, the equipment inside the Thermosciences Lab and the corresponding power are shown, with a total power of 7285 W.

Amount	Equipment	Power (W)
1	High level lamp	300
1	Infrared camera	120
1	Data acquire	75
2	HP desktop	240
2	Dell desktop	685
1	Cimarec thermogrill	1040
1	Cybron thermogrill	1300
1	KSL furnace	1400
1	OFT furnace	1200

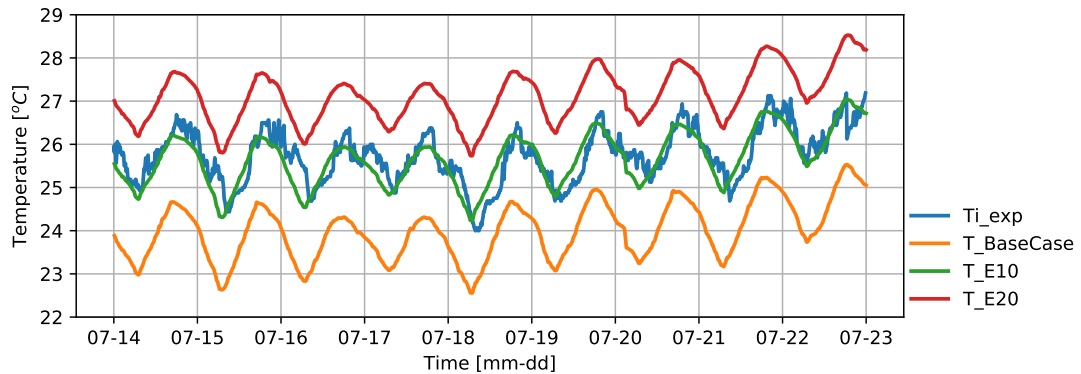
**Table 3.2:** Connected electric equipment inside the Lab. Amount, type and power from each equipment.

Two different cases were simulated, in which the percentage of total power consumed by the equipment was increased using a schedule of always on. The simulated cases were:

- 10% of total power from the equipment list: E10.
- 20% of total power from the equipment list: E20.

In Figure 3.6, the measured air temperature  $T_{i.exp}$ , the simulated temperature  $T_{BaseCase}$ , and results of the Equipment Loads Cases corresponding to 10% of total power  $T_{E10}$  and to 20% of total power  $T_{E20}$  are presented. It can be seen that there is a significant difference between the Base Case and those

with thermal loads from equipment. The T\_E10 case is the one which has a better approximation to the temperature measurements than the Base Case. The T\_E20 has higher temperatures than Ti\_exp.



**Figure 3.6:** Air temperatures simulated and measured. Equipment Loads Cases in percentage of the total power from the electric equipment that was connected: E10 in green line, E20 in red line. Measured air temperatures (Ti\_exp) in blue line. Orange line represents simulated temperatures from the Base Case.

### 3.3.3 Infiltration Case

In Figure 3.6, it can be seen that the results obtained in case E10 have a better approximation compared to the measured temperatures than the Base Case, but an increase in the air infiltration from the exterior may improve the results, in order to increase the temperature oscillation. So an Infiltration Case was proposed, it considers the 10% of total power from the equipment list and an increase in the Air Mass Flow Coefficient when the Opening is Closed. In the Base Case the value of the coefficient ( $0.0001\text{kg/s}$ ) corresponds to windows and doors from European and EEUU countries which are in general more airtight than these in Mexico. The change in the coefficient was considered in all openings from all the spaces. The proposed value of the Air Mass Flow Coefficient when the

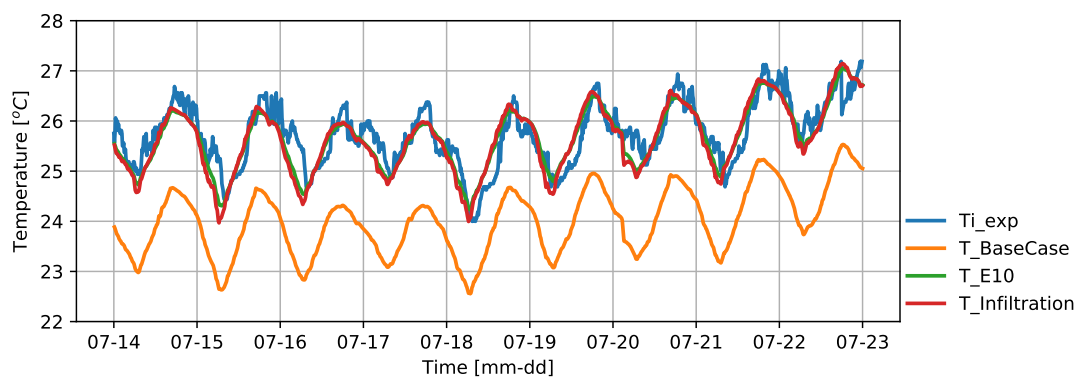


### 3. SIMULATION MODEL VALIDATION

---

Opening is Closed is  $0.001kg/s$  for this Infiltration Case.

In Figure 3.7, the air temperature measurements  $T_{i\_exp}$ , the results corresponding to the Base Case  $T_{BaseCase}$ , and results of the Infiltration case  $T_{Infiltration}$  and  $T_{E10}$  are presented. It can be notice that the amplitude of the temperature of the Infiltration case increased compared to the E10 case. The maxima temperatures are still underestimated compared to the measured but with an increase with respect the E10 ones. In some minima temperatures compared to the E10 case and the experimental temperatures are underestimated.



**Figure 3.7:** Comparison between temperatures simulated and measured. Measured air temperatures in blue line, Base Case in orange line, cases E10 and Infiltration in green and red lines, respectively.

### 3.4 Metrics for model validation

In previous subsections a qualitative comparisons between the temperature simulated and measured were presented, so to have a better way to quantify the differences between cases and experimental data, some metrics of Calixto, 2019 [12] were used.

The mean difference

$$\Delta T_i = \bar{T}_{i_{Exp}} - \bar{T}_{i_{Sim}} \quad (3.2)$$

where  $\Delta T_i$  is the daily mean difference between experimental and simulated temperature.

The minimum difference

$$\Delta T_{i_{min}} = T_{i_{min_{Exp}}} - T_{i_{min_{Sim}}} \quad (3.3)$$

where  $\Delta T_{i_{min}}$  is the daily minimum temperature difference between the experimental and simulated.

The maximum difference

$$\Delta T_{i_{max}} = T_{i_{max_{Exp}}} - T_{i_{max_{Sim}}} \quad (3.4)$$

where  $\Delta T_{i_{max}}$  is the daily maximum temperature difference between the experimental and the simulated.

The Decrement Factor difference

$$\Delta DF = DF_{Exp} - DF_{Sim} \quad (3.5)$$

where  $\Delta DF$  is the daily Decrement Factor  $DF$  difference between the  $DF$  experimental and the  $DF$  for the case simulated.

The  $DF$  measures the amplitude of the indoor temperature oscillation respect the amplitude of the outdoor temperature oscillation and is defined as:

$$DF = \frac{T_{i_{max}} - T_{i_{min}}}{T_{out_{max}} - T_{out_{min}}}, \quad (3.6)$$

where  $T_{out_{max}}$  and  $T_{out_{min}}$  are the maximum and minimum outside air temperature, respectively.

The daily Lag Time  $LT$  difference between the  $LT$  experimental and the  $LT$  for the case simulated, calculated by:

$$\Delta LT = LT_{Exp} - LT_{Sim}. \quad (3.7)$$

### 3. SIMULATION MODEL VALIDATION

---

Time lag is defined as difference on time between when the maximum indoor air temperature and maximum outdoor temperature occurs,

$$LT = t(T_{i_{max}}) - t(T_{out_{max}}). \quad (3.8)$$

The differences root mean square, for all data  $N$ , between the simulated air temperature  $T_{Sim_j}$  and the experimental air temperature  $T_{Exp_j}$ , was calculated as:

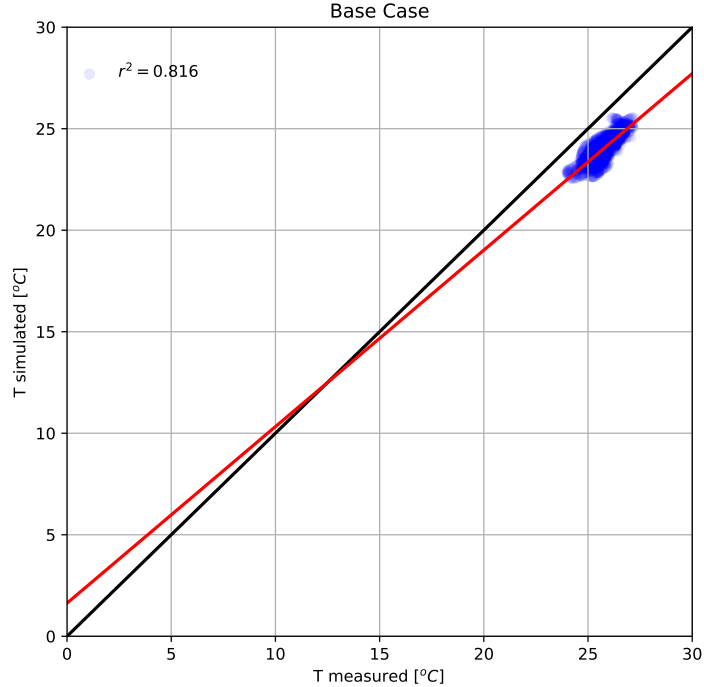
$$drms = \sqrt{\frac{1}{N} \sum_{j=1}^N (T_{Sim_j} - T_{Exp_j})^2}. \quad (3.9)$$

The last metrics for this comparison were  $m$  and  $b$  of the linear regression from each case and the temperature measurements. Linear regression attempts to model the relationship between two variables by fitting a linear equation. One variable is considered to be an independent variable, and the other is considered to be a dependent variable, in this case, experimental and simulated temperature respectively.

A linear regression has an equation form  $y = mx + b$ . The slope of the line is  $m$ , and  $b$  is the intercept, the value of  $y$  when  $x = 0$ . A  $m = 1$  and  $b = 0$  are the best expectation.

Figure 3.8 presents the linear adjustment of the Base Case. In figures 3.9a, 3.9b and 3.9c the zoom of the linear adjustment for the Base Case, E10 and Infiltration cases, respectively, are presented. In red line the linear adjustment to the data from each case and the black line represents the linear adjustment for a perfect match between the measured and simulated data.

Table 3.3 presents the average for the validation period of the metrics  $\Delta T_i$ ,  $\Delta T_{imin}$ ,  $\Delta T_{imax}$ ,  $\Delta DF$ ,  $\Delta LT$ , and  $drms$ ,  $m$  and  $b$ , all for the BaseCase, E10 and Infiltration cases. For  $\Delta T_i$ , the best cases were the E10 and Infiltration with  $0.1^\circ C$  and the worst case was the Base Case with  $1.7^\circ C$ . For  $\Delta T_{imin}$ , the best cases for this metric is E10 with  $0.0^\circ C$  and the worst case was for Base Case with



**Figure 3.8:** Linear adjustment. The measured and Base Case air temperatures.

$1.7^{\circ}\text{C}$ . In  $\Delta T_{imax}$  the best performance was case Infiltration with  $0.3^{\circ}\text{C}$ . The worst performance was for Base Case with  $1.9^{\circ}\text{C}$ . For  $\Delta DF$  the best results was Infiltration case, in which the difference is 0.0. The worst case was for E10 with 0.02. For  $\Delta LT$ , the best case was E10 with 65 minutes and the Infiltration is the worst with 105 minutes. When calculating  $drms$  the best cases were E10 and Infiltration with  $0.3^{\circ}\text{C}$  and the worst result is for Base Case with  $1.7^{\circ}\text{C}$ . The best value of metric  $m$  was for Base Case with 0.87 and the worst case with 0.82 for the case E10. For  $b$  the best results was for Base Case with  $1.6^{\circ}\text{C}$  and the worst case corresponding to E10 with  $4.6^{\circ}\text{C}$ , which are a contradiction in the results obtained, considering that the Base Case underestimates the measured temperature and the E10 and Infiltration had a better comparison to the measured data than the Base Case.

In Figure 3.7, the difference when the maximum temperatures occur between

### 3. SIMULATION MODEL VALIDATION

---

Case	$\Delta T_i$ (°C)	$\Delta T_{imin}$ (°C)	$\Delta T_{imax}$ (°C)	$\Delta DF$ (-)	$\Delta LT$ min	$drms$ (°C)	$m$ (-)	$b$ (°C)
BaseCase	1.7	1.7	1.9	0.01	90	1.7	0.87	1.6
E10	0.1	0.0	0.4	0.02	65	0.3	0.82	4.6
Infiltration	0.1	0.2	0.3	0.00	105	0.3	0.86	3.6

**Table 3.3:** Metrics used to validate simulation mode and values results for each case.

E10 and Infiltration cannot be noticed, so to be sure that the values of the metric  $\Delta LT$  are correct, the results were verified. In Figure 3.10, the daily plot of  $\Delta LT$  is presented. As can be seen in four of nine days,  $\Delta LT$  of Infiltration case is higher than E10 case. In Figure 3.11 the difference in time, when the maximum temperatures from the E10 and the Infiltration cases occurs for July 14th, 17th and 20th are presented, and as can be seen, the higher temperature of Infiltration case occurs before the higher temperature of E10 case with minimum one hour of difference. With these information, it was concluded that the metric  $\Delta LT$  is correct.

As can be notice in Table 3.3, the Base Case has the best results for metrics  $m$  and  $b$ , even its temperature values underestimated the measured ones, as well with the E10 and Infiltration temperatures simulated. So a change to evaluate metrics  $m$  and  $b$  was considered. The linear adjustment was calculated with:  $(T - T_{min})$ , where  $T$  is the air temperature and  $T_{min}$  is the minimum value from the air temperature measured. In figures 3.12, 3.13 and 3.14 the change of the linear adjustment for the Base Case, E10 and Infiltration cases, respectively, are presented. In Figure 3.12, it can be seen that the simulated results underestimated the measured ones with  $1.5^\circ C$  but with a similar slope. In figures 3.13 and 3.14, it can be notice that for E10 and Infiltration cases the simulated

temperature are overestimating the measured temperature.

In Table 3.4, the same values from metrics  $\Delta T_i$ ,  $\Delta T_{imin}$ ,  $\Delta T_{imax}$ ,  $\Delta DF$ ,  $\Delta LT$ , and  $drms$  are presented. Values for metrics  $m$  and  $b$  are updated, and named  $m2$  and  $b2$ . The obtained values of metric  $m2$  are the equal than  $m$  because the slope is the same, the only change was to set the values where the lowest measured temperature is. For metric  $b2$  the best results were for E10 and Infiltration cases with  $0.2^\circ C$  and the worst case corresponds to Base Case with  $-1.5^\circ C$ , which now is a negative value. As it was expected, values for  $b2$  have a better comparison with measured air temperature than  $b$ , because the linear adjustment with the change, now represents correctly the conditions.

Case	$\Delta T_i$ ( $^\circ C$ )	$\Delta T_{imin}$ ( $^\circ C$ )	$\Delta T_{imax}$ ( $^\circ C$ )	$\Delta DF$ (-)	$\Delta LT$ min	$drms$ ( $^\circ C$ )	$m2$ (-)	$b2$ ( $^\circ C$ )
BaseCase	1.7	1.7	1.9	0.01	90	1.7	0.87	-1.5
E10	0.1	0.0	0.4	0.02	65	0.3	0.82	0.2
Infiltration	0.1	0.2	0.3	0.00	105	0.3	0.86	0.2

**Table 3.4:** Metrics used to validate simulation mode and values results for each case, with  $m$  and  $b$  updated, and named  $m2$  and  $b2$  .

Case E10 has the best results for metrics  $\Delta T_{imin}$  and  $\Delta LT$ . E10 together with Infiltration had the best results for metrics  $\Delta T_i$ ,  $drms$  and  $b2$ . Infiltration Case has the best results for metrics  $\Delta T_{imax}$  and  $\Delta DF$ . Base Case has the best results for metric  $m2$ .

### 3.5 Methodology for building simulations

In this section, the methodology suggested for building simulations, based on the experience obtained in this thesis is presented. In AppendixC, a flux diagram

### 3. SIMULATION MODEL VALIDATION

---

of this is exposed and briefly described. This methodology will help to perform a proper simulation employing EnergyPlus in a space without the use of air-conditioning systems and its validation with experimental measurements. The methodology is divided in two main stages: Data gathering and, simulations and analysis.

#### **Data gathering:**

- Building information: architectural planes, construction systems, materials, latitude, longitude, surroundings shading elements (buildings, trees, hills).
- Spaces characteristics: people, activity, lights, electrical equipment, internal mass, schedules.
- Experimental measurements: indoor air temperature and weather information.

#### Methodology **Simulations and analysis:**

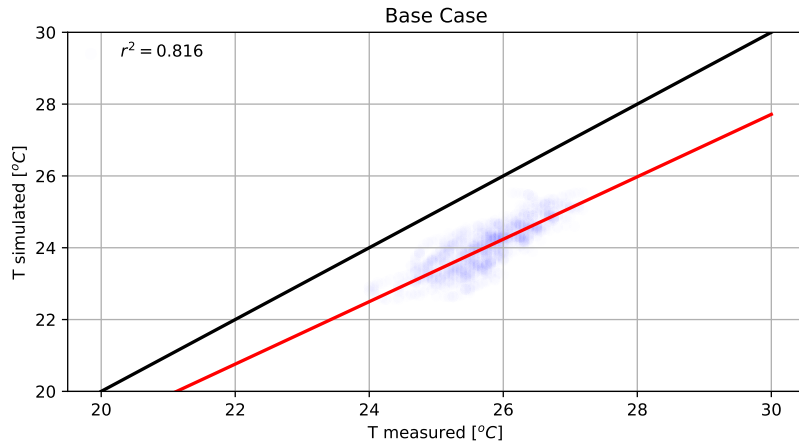
1. Simplifications in geometry, thermal zones, boundary conditions, shading elements.
2. Draw simulation model with simplifications.
3. Define spaces types, its characteristics and schedules: people, lights, electrical equipment, natural ventilation, shading controls.
4. Include natural ventilation and infiltration in all spaces, with the Airflow network.
5. Create weather file.
6. Define and simulate the base case.
7. Do a qualitative comparison with measured indoor air temperature.

8. If the results are not the expected compared to the experimental data, propose and simulate new cases with variables that can be change from the base case.
9. Compare indoor air temperature results of new cases with measured data.
10. Do a quantitative comparison of the air temperature with all cases, with metrics from the literature.
11. Select the best case.

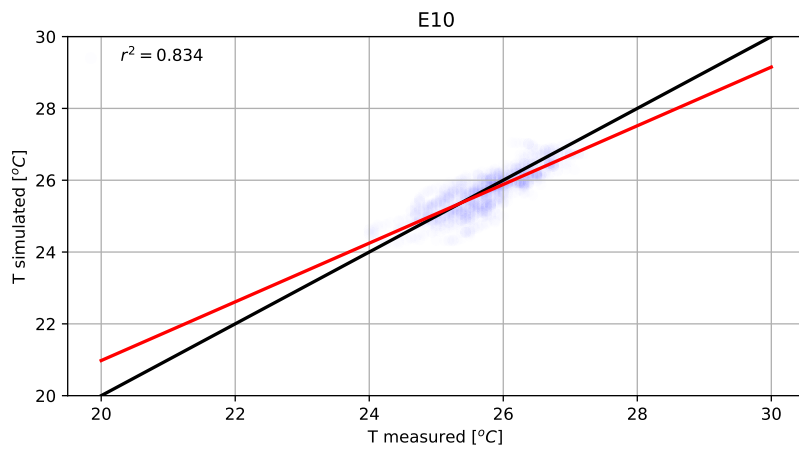


### 3. SIMULATION MODEL VALIDATION

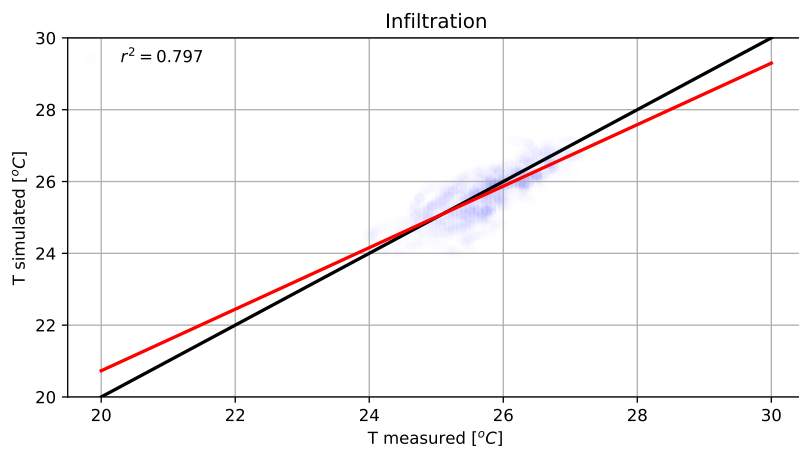
---



(a)



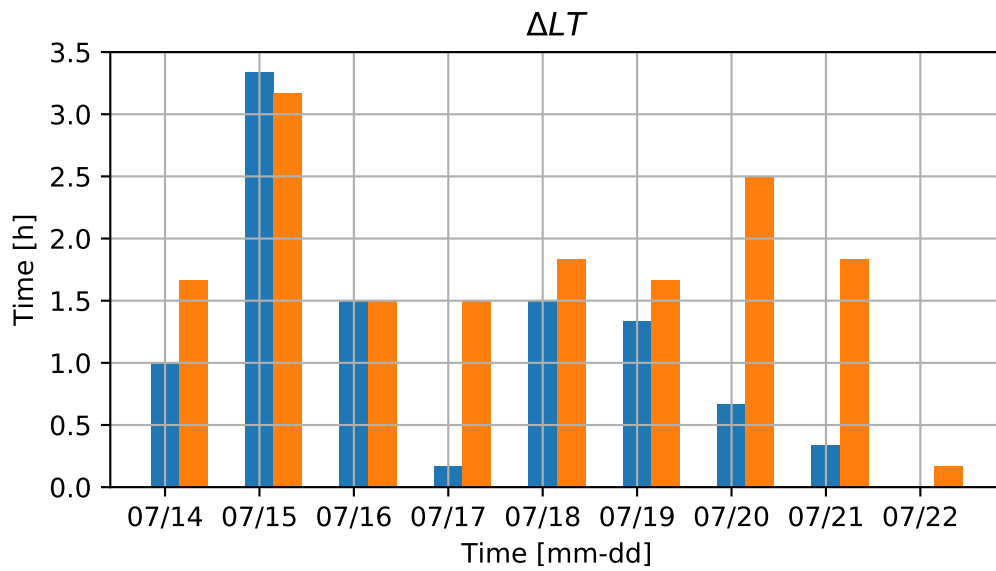
(b)



(c)

**Figure 3.9:** Zoom plot of the linear adjustment for simulated temperatures. In Figure a, the Base Case. In Figure b, E10 case. In Figure c, Infiltration case.

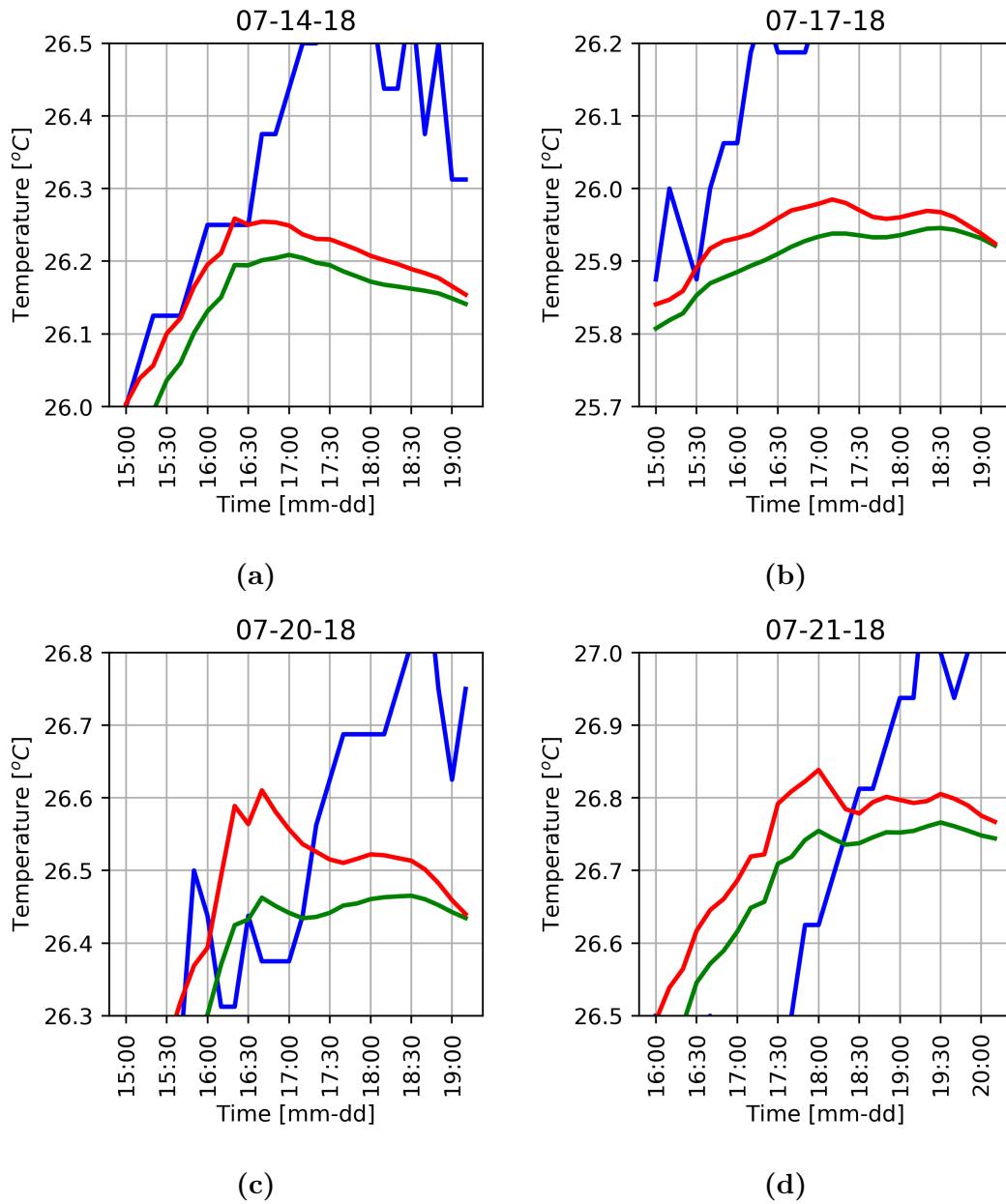
---



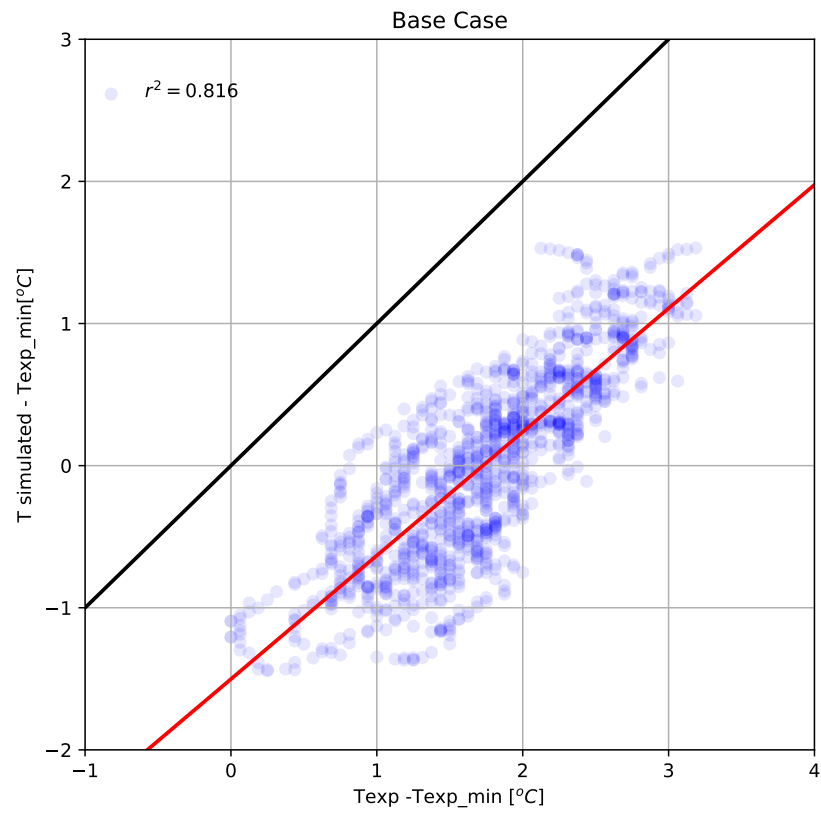
**Figure 3.10:** Daily  $\Delta LT$ . Results, In blue and orange of E10 and Infiltration cases, respectively.

### 3. SIMULATION MODEL VALIDATION

---



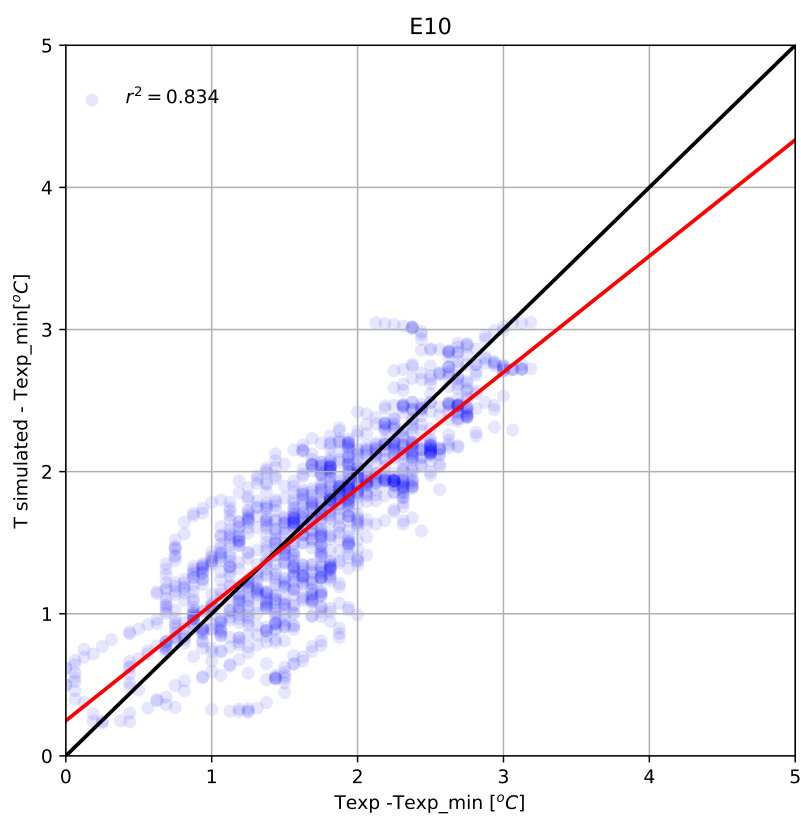
**Figure 3.11:** Zoom plot for simulated temperatures for July 14th a, 17th b, 20th c and 21st d. Experimental measurements in blue line. Infiltration case temperatures in red line. E10 case temperatures in green line.



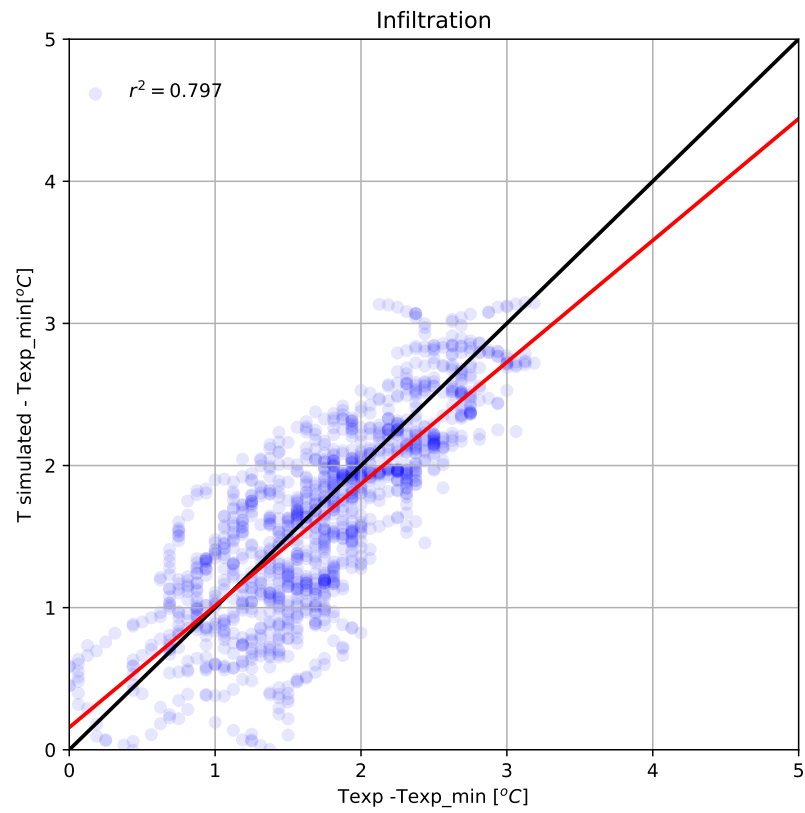
**Figure 3.12:** The linear adjustment with change, for Base Case temperatures.

### 3. SIMULATION MODEL VALIDATION

---



**Figure 3.13:** The linear adjustment with change, for E10 temperatures.



**Figure 3.14:** The linear adjustment with change, for Infiltration Case temperatures.



---

## Chapter 4

# Conclusions

---

In this thesis a methodology and considerations that help to perform a proper simulation of a building and the validation in a specific space without the use of air-conditioning systems using EnergyPlus, is provided. This methodology is divided in two main stages: Data gathering and, simulations and analysis.

Building 3.1 from the Renewable Energies Institute (IER-UNAM) was simulated, considerations and simplifications were taken to create a simulation model of Thermosciences Lab inside the building. In the geometry model, the spaces destined for electric boards and cleaning rooms were not considered, however these were simulated with surfaces with a boundary condition of no sun exposure. All eaves, were implemented as equivalent eaves instead of multiple ones. A complex shading system was simulated with a single shading element which had an equivalent transmittance. The hill in the north-east façade was simulated as an equivalent shading surface. It was simulated an equivalent shading surfaces instead of stairs. The photovoltaic systems were proposed as equivalent shading surfaces. Vented double walls were simulated with a discharge coefficient of a window with insect-proof screen. Non-vented double walls were simulated without natural ventilation and without internal loads. Internal mass was added in all spaces with three constructions corresponding to materials from columns, metal and wood furniture. All spaces were simulated with an Airflow network



#### 4. CONCLUSIONS

---

model with infiltration in all windows and with any internal load for equipment, lights or people. All this considerations were defined as the Base Case of the simulation model for the Thermosciences Lab in Building 3.1. The results of the air temperature simulated of the Base Case compared to the measured ones are underestimated with up to  $2^{\circ}C$ .

Three additional cases were simulated, for Equipment Loads Cases were simulated E10 and E20 with 10% and 20% of total power from equipment, respectively. Infiltration case was simulated with 10% of total power from electrical equipment connected and with an increase in the Air Mass Flow Coefficient When Opening is Closed.

A qualitative comparison for all cases was made with plots between simulated and measured air temperature. With this qualitative comparison was noted that air temperature results from Base Case underestimated the measured air temperature but had a similar behaviour in the oscillation of the experimental temperature. When considering thermal gains from electrical equipment on standby in E10 and E20 cases, was noticed that this gains can be an important factor in obtaining higher air temperatures. In the qualitative comparison between E10 and the experimental data, it was noted that even the air temperature simulated were closed to the measured air temperature some temperature peaks are overestimated and others underestimated. For this reason case Infiltration was proposed with the same considerations from E10 but with a increase in the Air Mass Flow Coefficient When Opening is Closed in order to obtain a better match in the amplitude of the temperature oscillation simulated with the measured. In the simulation results from Infiltration case, the maxima temperatures are underestimated compared to the measured but with an increase with the E10 ones. In some minima temperatures are overestimated compared to the experimental data and E10 results.

---

To have a better way to compare the differences between Base Case, E10 and Infiltration cases results and experimental data, eight metrics were used for a quantitative comparison:  $\Delta T_i$ ,  $\Delta T_{imin}$ ,  $\Delta T_{imax}$ ,  $\Delta DF$ ,  $\Delta LT$ ,  $\Delta drms$ ,  $m2$  and  $b2$ . The mean temperature between experimental and the simulated temperature,  $\Delta T_i$ , from the best cases E10 and Infiltration is  $0.1^\circ C$ . The average of the minimum difference between experimental and the simulated temperature,  $\Delta T_{imin}$ , best results is from case E10 with no difference, and for the maxima,  $\Delta T_{imax}$ , is for Infiltration case with  $0.3^\circ C$ . The best results in the mean difference in the Decrement Factor between experimental and simulated,  $\Delta DF$ , is from Infiltration Case with no difference. For the mean difference in Lag Time between experimental and simulated, the best result is from E10 with 65 minutes. The average difference of all data,  $\Delta drms$ , between the simulated and experimental air temperature from the best cases, E10 and Infiltration, is  $0.3^\circ C$ . The Base Case has the best result for metric  $m2$  with a value of 0.87. For metric  $b2$  the best results were for E10 and Infiltration cases with  $0.2^\circ C$ . The correction in metrics  $m$  and  $b$ , named  $m2$  and  $b2$ , is helpful to evaluate the linear adjustment only in the measured temperature range. The quantitative comparison evaluated with metrics, it indicates that the results obtained from the simulations for the E10 and Infiltration cases had a good comparison between the measured air temperature, giving good results in all of them. Although both cases had good results in different metrics, E10 has the best result for metric  $\Delta LT$  with a difference of 40 minutes compared with the Infiltration case, which can be important when is analysed with experimental data. Even though, a qualitative comparison is helpful to notice the differences between the cases and the measured data, the use of metrics helps to select the best case when the results have qualitatively similar behaviour. It is difficult to conclude the best case using a single metric, so it is recommended to use different metrics commonly used in the literature. For

#### 4. CONCLUSIONS

---

the goods results obtained in the qualitative and quantitative comparison with measured data, E10 and Infiltration cases can be considered as validated.

Due to the qualitative comparison and the values of the metrics obtained, the methodology suggested for buildings simulations in this thesis can be used to simulate buildings with spaces that do not use air-conditioning systems. For other simulation models it is essential to include in all spaces the expected internal mass, internal gains from people, lights and electrical equipment, in stand by and in use with the supposed schedules.

Due to the results obtained in this thesis, it is important to promote a culture of energy saving and avoid in spaces the additional thermal gains of the electrical equipment on standby by unplugging electrical equipment when are not in use, which can increase the indoor temperature, in the space studied, close to  $2^{\circ}C$ . This can be achieved through campaigns made by the authorities and specialists in the areas to create consciousness among all the occupants.

---

## Appendix A

# Materials, constructions and constructions sets

---

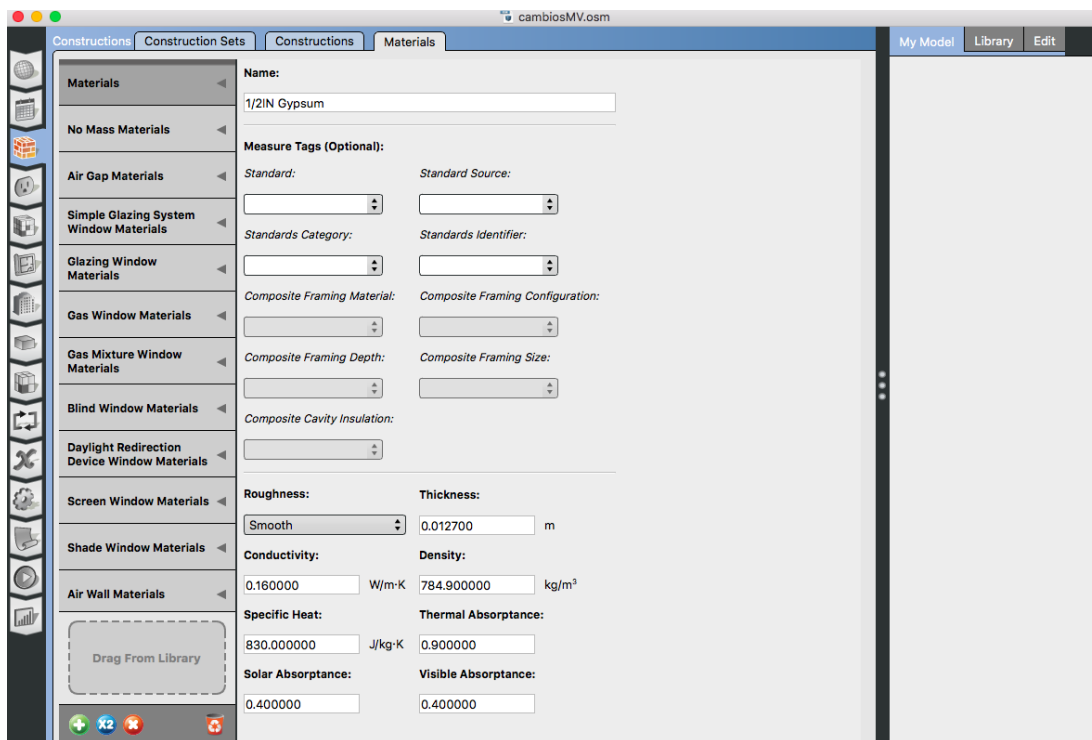
In this appendix how to add new Materials, Constructions and Construction Sets in OpenStudio is explained. In Figure A.1 it can be seen the OpenStudio Construction tab and Materials sub-tab.

### **A.1 Materials**

OpenStudio allows to model different types of Material objects: Materials, No Mass Materials, Air Gap Materials, Windows Materials (Glazing, Blind, Gas, Blind) and Roof Vegetation Materials, this appendix will focus on how to add "opaques" Materials which is the material that should be used when the four main properties (thickness, conductivity, density, and specific heat) of the material are known.

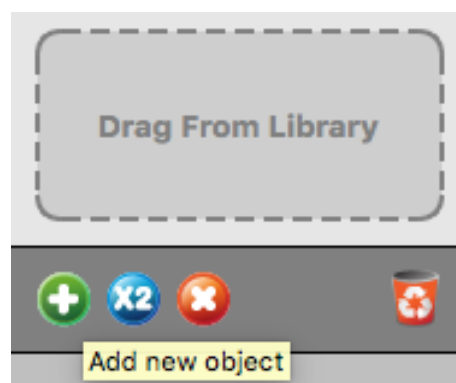
At the Constructions Tab in the OpenStudio interface, which is divided by three Sub-Tabs: Construction Sets, Constructions, and Materials, the first step in the process is to define properties for the Materials. This appendix focuses on the "opaques" Materials, so to add a new material must be clicking in Materials Sub-Tab and press the button "add new object", the green plus circle, this button

## A. MATERIALS, CONSTRUCTIONS AND CONSTRUCTIONS SETS



**Figure A.1:** OpenStudio Constructions tab, Materials sub-tab and thermal properties to be defined.

is located in the lower left corner of Figure A.1.



**Figure A.2:** OpenStudio Add new object button in green circle with a plus symbol inside.

This new material must have the follow properties:

- Roughness
- Thickness
- Conductivity
- Density
- Specific heat

In the Roughness field the relative roughness of the material must be defined. This parameter will only have influences in the exterior convection coefficients. The thickness field, is the thickness of the material layer in meters. The Input Output Reference explains that this characteristic should be the dimension of the layer in the direction perpendicular to the main path of heat conduction, and must be to modeling layers no less than 0.003 *m*. Conductivity is used to enter the thermal conductivity of the material in *W/mK*. This field must be greater than zero and not higher than 5.0 *W/mK*. Density must be a positive quantity of the material layer in *kg/m* units and specific heat field should be in *J/kgK* units with values of 100 or larger.

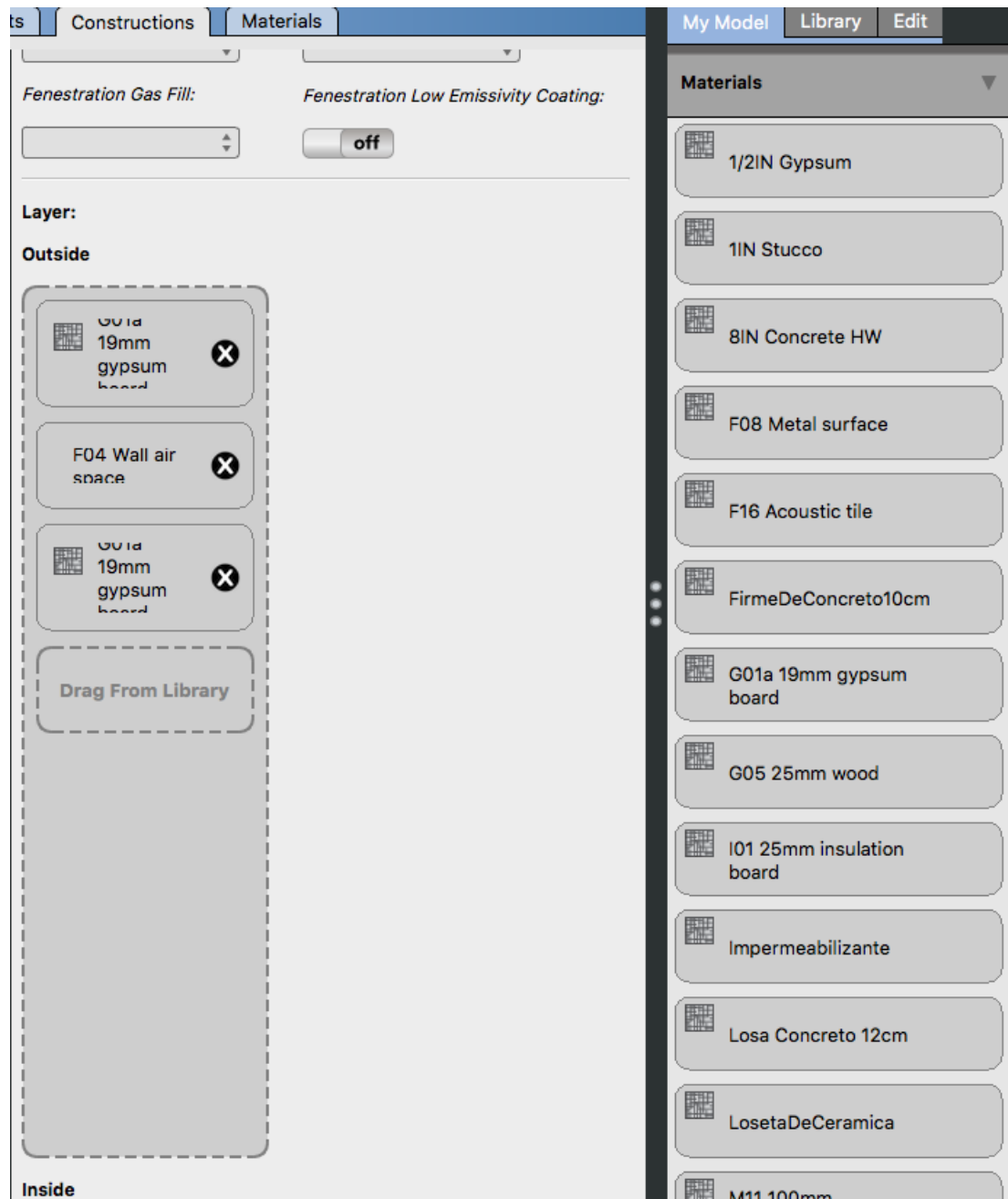
## A.2 Constructions

To create the constructive systems of the simulation model it is necessary to add new Constructions. In the Constructions Sub-Tab, the “Constructions” object type must be selected and use the ”add new object” button. To add materials to the new Construction, the Materials in to the “Drag from Library” zone in the Construction editor must be dragged and it could be Materials from ”My Model” or from the ”Library”. It is important to mention that each layer of the

## A. MATERIALS, CONSTRUCTIONS AND CONSTRUCTIONS SETS

---

construction is a material name listed in order from “outside” to “inside”. It is only allowed to use up to ten layers. “Outside” is the layer furthest away from the Zone air (not necessarily the outside environment). “Inside” is the layer next to the Zone air as seen in Figure A.3. Window constructions are similarly built up, from items in the Window Materials set using also layers in order from “outside” to “inside” but as a variance from the “Constructions” object type the Windows constructions only allow eight layers.



**Figure A.3:** OpenStudio Constructions Sub-tab, layers in order from outside to inside. Materials "My Model" in right side.



### A.3 Construction set

The following steps should be done under the *constructions* tab. It is important to mention, to configure the *Construction Sets*, that the constructions layers had to be placed as a "mirror". Such as the materials of the interior floors and the interior ceilings, where the first of them is dragged from the outside to inside and vice versa. Also it is essential to choose an appropriate name, referring the place where it be settled.

To create *Construction Set*, it is required to add a new object and named it. The next step is to drag each *construction* from *My model* to the corresponding place.

There are different methods to select the new construction set to a space:

- Adding it to the *general properties space* as a *default construction set*.
- Choosing it as a *default construction set name* in the *stories facility* tab in each *building story*.
- Selecting it from the *building facility* as a *default Construction Set*.

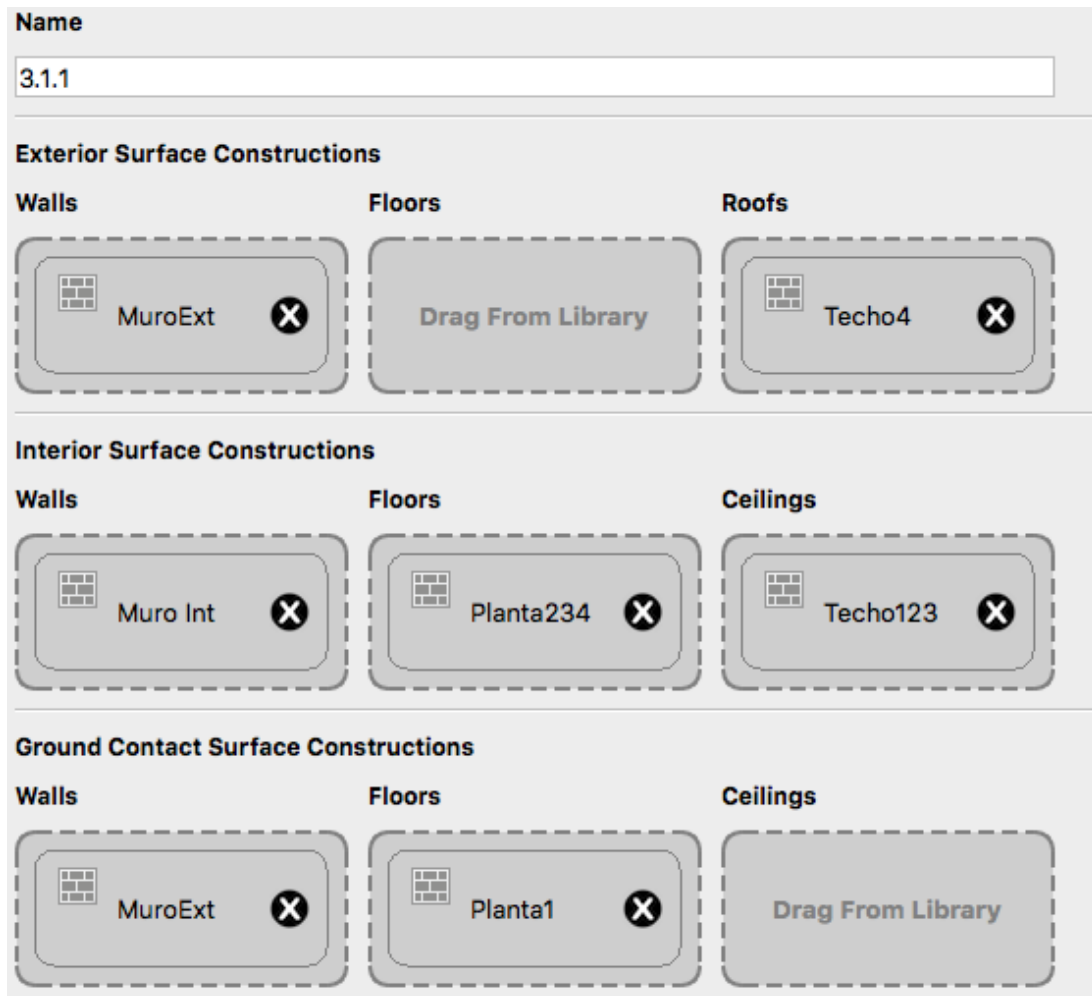
To finish the process and prove it was carried out correctly, the simulation must be run and verified there are no error in the *eplusout.err* file.

## A.4 Materials and thermal properties of Building 3.1

In this section, the materials and its thermal properties used to simulate the Building 3.1 are exposed.

Material	Thermal conductivity ( $W/mK$ )	Density ( $kg/m^3$ )	Specific heat ( $J/kgK$ )
HDC	1.35	1800	1000
Ceramic tile	0.8	1700	850
Mortar plaster	1.0	1800	1000
Red brick	0.7	1970	800
Gypsum	0.16	784.9	830
Metal decking	45.0	7680	418
Wood	0.15	608	1630

**Table A.1:** Constructions, materials and its thermal properties for Building 3.1. Columns are made of high density concrete (HDC).



**Figure A.4:** OpenStudio Construction sets tab, Constructions defined by Surface type.

---

## Appendix B

# EnergyPlus weather file

---

In this appendix the steps to follow for a creation of an EnergyPlus weather file (EPW), the use of Weather Converter program are explained. The files needed to create examples of each of them are presented.

## B.1 Weather Converter

The Weather converter program consists of two parts: a user interface that executes the data and an interface for processing. To do an EPW file it is necessary access to the one that executes the files with standard graphical user interface menus. It is executed from the Start Menu programs using the specific folder where the EnergyPlus program was installed.

As seen in the Figure B.1, the first tab indicates the input weather data file to convert. After this folder is specified, the data type is automatically filled. The next step is to choose the output format. In this case, an EPW file is needed, but there are other options, such as csv or both, which consists of a csv and EPW files and a statistical report of the weather data. The Save File As button selects the location to save the new output file. The Weather converter automatically places a data type extension on the new file. Here it is important to warn that if there is a previous file with the same name, the program will overwrite it. The last

## B. ENERGYPLUS WEATHER FILE

---

step is to click on the Convert File tab to finish the data processing. If a warning notifying an error is displayed, the csv and the def files should be checked.

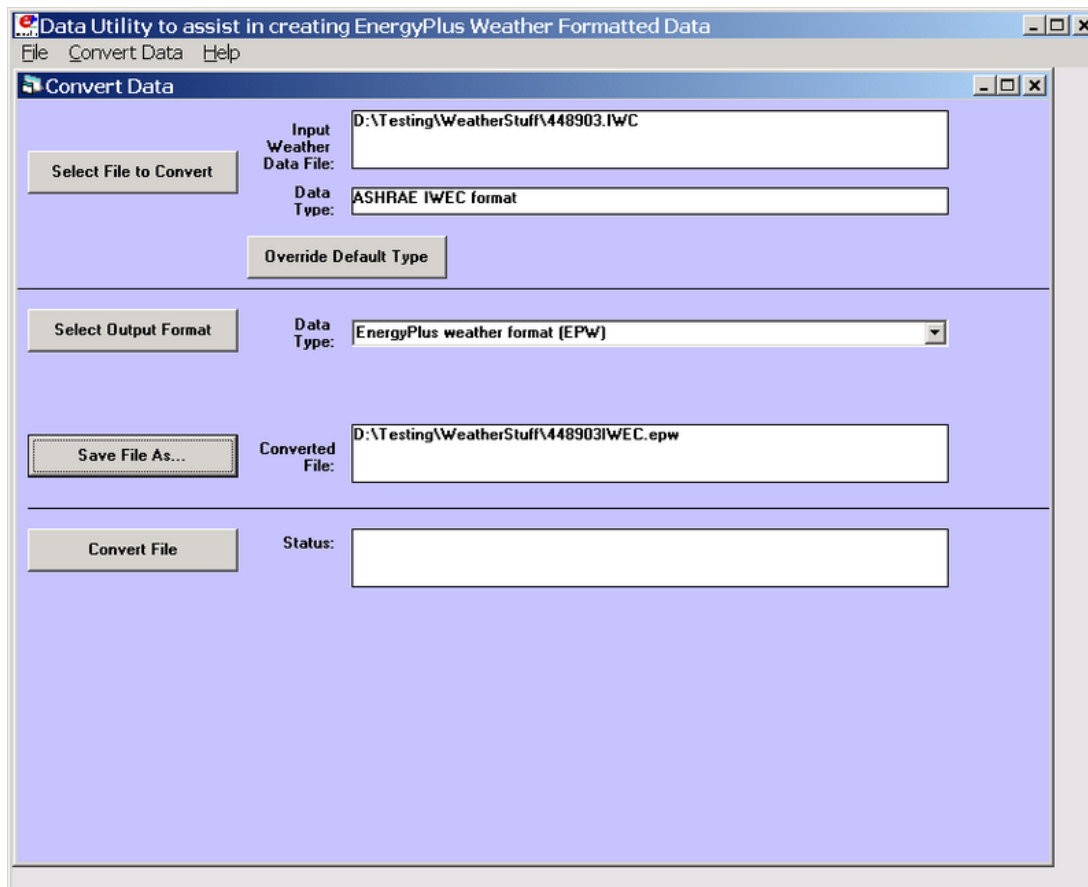


Figure B.1: Weather converter interface.

### B.1.1 Definitions file

Weather Converter will use the format and data that is specified in the definitions file (.def), this file must have the same name as the input file and be located in the same folder. An error would occur if those are in different folders.

The first step to define the .def file is to write the header. To do correctly it will be helpful to be guided in other EPW file. In the EnergyPlus file, some

examples of EPW that would help as example are explained. The header needs the principal information of the location:

- Name of the city
- State of Province
- Country code
- Latitude
- Longitude
- Time zone
- Elevation

## B. ENERGYPLUS WEATHER FILE

---

Each of one has a short field name that is request in the .def file, in Figure B.2 are exposed.

<b>&amp; location Field Description</b>	<b>Field Name</b>	<b>Type</b>
Name of City	City	String
State or Province	StateProv	String
Country Code	Country	String (3 characters)
Latitude (N+/S-)	InLat	Numeric
Longitude (W-/E+)	InLong	Numeric
Time <u>Zone</u> (GMT +/-)	InTime	Numeric
Elevation (meters)	InElev	Numeric
WMO #	InWMO	Numeric or String (6 characters)

**Figure B.2:** Location fields description, its name and type that must be used in the heather of the Definition File.

The field of the location has to indicate the following characteristics exposed. City can be up to 30 characters in length, for State or Province up to 15 characters and for the Country up to 10 characters, with the standard of 3 character abbreviation preferred. For the Latitude and Longitude are decimal equivalents. For this field the convention is that the North Latitude is positive and South is negative, the East Longitude is positive and the West Longitude is negative. The decimal Time Zone value describes the InTime field. The Elevation field allowed range -300 *m* to 6089 *m* above the sea. The last field is InWMO, which is the World Meteorological Organisation number where the location is. If this field is not known or assigned the Weather Converter program will not notify an error. After filled all the header options, a slash (/) character terminating as in each

block is required. An omission of it will result in incorrect reading of the data. If a comment is essential to understand the .def file or to specify the source where the data were obtained, the misc-data should be filled. If there is no comments or source, this field can be in blank.

The weather data format is essential to do a correct EPW. In this field, the weather data to convert from the csv source is exposed.

- NumInHour: is the first module to complete, this item stipulates the time step per hour for the EnergyPlus weather. 6 is for a 10 minutes timestep.
- InputFielType: "Custom" is the only format allowed.
- InFormat: should be "Delimited" if there is using a free format data file or specify a "Fortran style" format statement.
- DataElements: Indicates which row from the csv will be used. It is helpful to employ the short name from the Internal data elements names image. "Ignore" is used to skip a raw data field that is not applicable to the weather converter formats. Also it is indispensable to write the data elements in order as the rows of the csv.
- DataUnits: There are EPW default names in the Internal data elements names figure and there should be as many DataUnits entries as DataElement entries.
- DataConversionFactors: The conversion factors are multiplicative factors so the value from csv row will be multiplied by this factor. If the data from every row is in the same units as the Internal data elements names image a "1" would be fill. Also, there must be as many DataConversionFactors entries as DataElement entries.



## B. ENERGYPLUS WEATHER FILE

---

- `DelimiterChar`: For the csv format, a delimiter this field should be fill with a comma (,).

In Figure B.3, the names for the `DataElements` and the default EPW units for `DataUnits` are shown. There are other fields that could be find in the Weather Converter documentation.

The next step is to fill out the `DataControl`:

- `NumRecordsToSkip`: This field must be used to specify if there is some information at the top of the csv that has to be skipped at the processing.
- `MaxNumRecordsToRead`: It must be used if the input file has some information after the data records or if it is wanted a monthly data for the EPW.

To finish the .def file, a slash (/) character is required at the end. An example of a .def file at the end of this appendix is shown.

### B.1.2 CSV file

The csv file is the data where the .def file will take the values. To avoid an error, it is necessary to locate the rows in the same sequence as the DataElements of the .def procedure. An omission of the information at the top of the csv such as units or names row should be done. This advice is to avoid a possible warning when the EPW is running.

## B.2 EPW validation

In this section, the validation of the EPW used to simulate the Building 3.1 is presented.

Once the EPW file is constructed, it is recommended to verify the data, in order to verify the weather file was correctly made. A simulation was done in order to check the information between EnergyPlus simulated variables (.Sim) and the data from the Esolmet (.Esolmet). It was compared the following EnergyPlus variables:

- Site Outdoor Air Drybulb Temperature.
- Surface Outside Face Incident Solar Radiation Rate per Area.
- Site Direct Solar Radiation Rate per Area.
- Wind speed.

It is expected that the data from the simulation (.Sim) should overlap the data from the Esolmet (.Esolmet).

In Figure B.5, the Site Outdoor Air Drybulb Temperature variable from the simulation (Tout\_Sim) and corresponding temperature data from the Esolmet (Tout\_Esolmet) are presented. In Figure B.6, the Surface Outside Face Incident

## B. ENERGYPLUS WEATHER FILE

---

Solar Radiation Rate per Area variable on a horizontal surface from the simulation (Ig\_Sim) and the global radiation per area from the Esolmet (Ig\_Esolmet) are presented. In Figure B.7, the Site Direct Solar Radiation Rate per Area variable from the simulation (Id\_Sim) and the outdoor direct radiation per area from the Esolmet (Id\_Esolmet) are presented. Finally in Figure B.8, the Environment Site Wind Speed variable from the simulation (WindSpeed\_Sim) and the wind speed from the Esolmet (WindSpeed\_Esolmet) are presented. In Figures B.5, B.6, B.7 and B.8 the data corresponds to four days of July. As it was expected, the data between the simulation and that from the Esolmet are overlapped in all figures and the EPW can be used to simulate the Building 3.1 model.

Short Name	Long Name	Default EPW Units	Used by EnergyPlus
year	Year	-	n
month	Month	-	y
day	Day	-	y
hour	hour	-	y
minute	minute	-	n
datasource	datasource	-	n
drybulb	dry_bulb_temperature	C	y
dewpoint	dew_point_temperature	C	y
relhum	relative_humidity	%	y
atmos_pressure	atmospheric_pressure	Pa	y
exthorrad	extraterrestrial_horizontal_radiation	Wh/m2	n
extdirrad	extraterrestrial_direct_normal_radiation	Wh/m2	n
horirsky	horizontal_infrared_radiation_intensity_from_sky	Wh/m2	y
glohorrad	global_horizontal_radiation	Wh/m2	n
dirnorrad	direct_normal_radiation	Wh/m2	y
difhorrad	diffuse_horizontal_radiation	Wh/m2	y

**Figure B.3:** Internal data elements names required for a EnergyPlus weather file. In first column are shown the short names used in .def file, in second column are presented the long name for each variable, third column shows the units used by the EPW and in fourth columns the character used by EnergyPlus.

## B. ENERGYPLUS WEATHER FILE

---

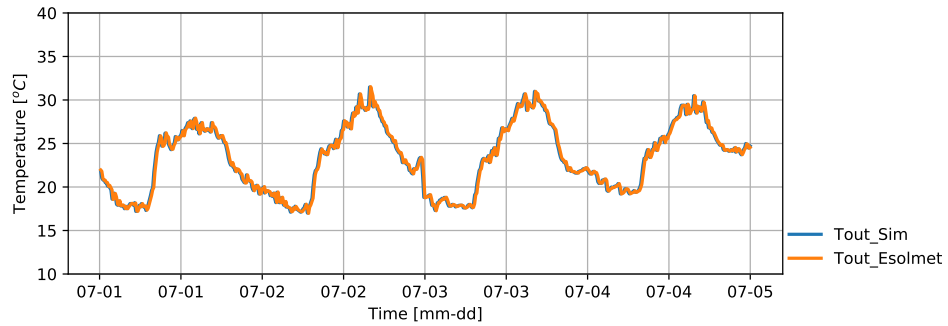
```
&location
City = 'Beijing'
StateProv = 'Beijing'
Country = 'CHN'
InWMO = '545110'
InLat = 39.92
InLong = 116.27
InElev = 55
InTime = 8
/

&miscdata
Comments1 = 'China Data Set - Zhang/Huang'
/

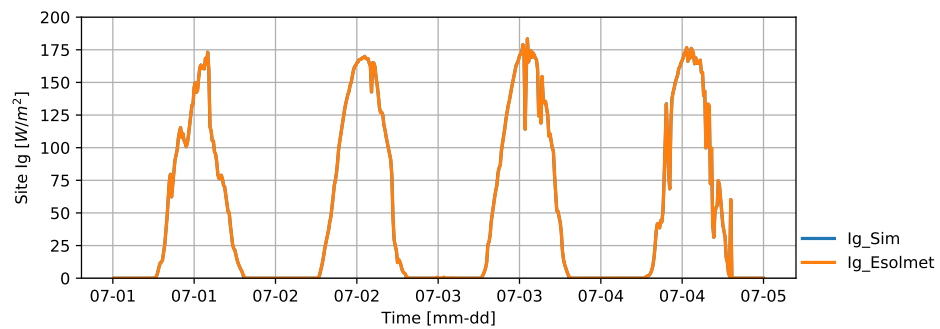
&wthdata
NumInHour = 1
InputFileType = 'CUSTOM'
InFormat = 'DELIMITED'
DataElements = Ignore,Year,Month,Day,Hour,Ignore,DryBulb,DewPoint,Ignore,Relative_Humidity,Ignore,DirNorRad,DifHorRad,WindDir,Wind_Speed,OpaqSkyCvr,Atmos_Pressure
DataUnits = x,x,x,x,x,x,'k','k',x,'% ',x,'wh/m2','wh/m2','deg','m/s',x,'Pa'
DataConversionFactors = 1,1,1,1,1,1,.1,.1,1,1,1,1,1,1,.1,.1,10
DelimiterChar = ' '
/

&datacontrol
NumRecordsToSkip = 0
MaxNumRecordsToRead = 8760
/
```

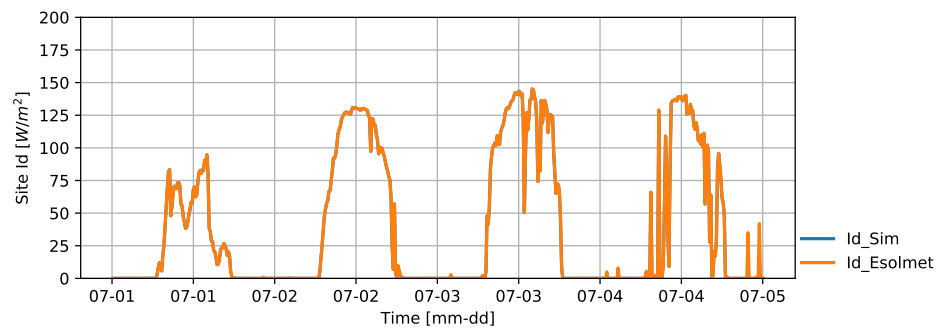
**Figure B.4:** Example of a .def file, include header, Data elements and weather data format.



**Figure B.5:** Site Outdoor Air Drybulb Temperature from the simulation and the Outdoor temperature from Esolmet.



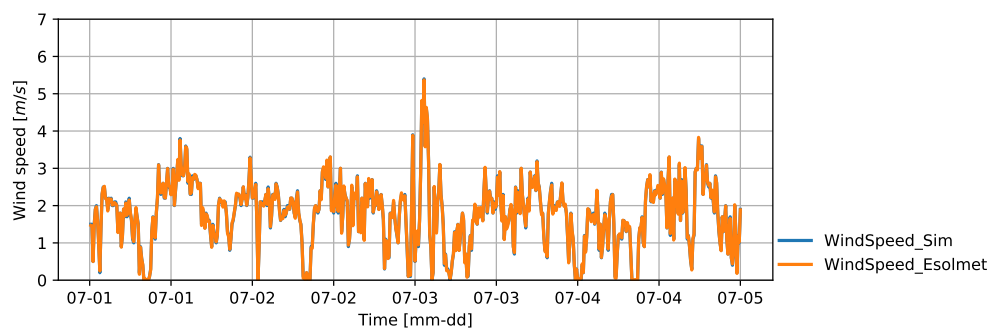
**Figure B.6:** Surface Outside Face Incident Solar Radiation Rate per Area from the simulation and Global radiation from Esolmet.



**Figure B.7:** Site Direct Solar Radiation Rate per Area from the simulation and Outdoor direct radiation from Esolmet.

## B. ENERGYPLUS WEATHER FILE

---



**Figure B.8:** Environment Site Wind Speed from the simulation and Wind speed from Esolmet.

---

## Appendix C

# Methodology flux diagram

---

In this appendix, the flux diagram of the methodology to simulate a complex building and the validation in a space of this thesis, in Figure C.1 is presented. In Figure C.2, the flow diagram symbols are presented.

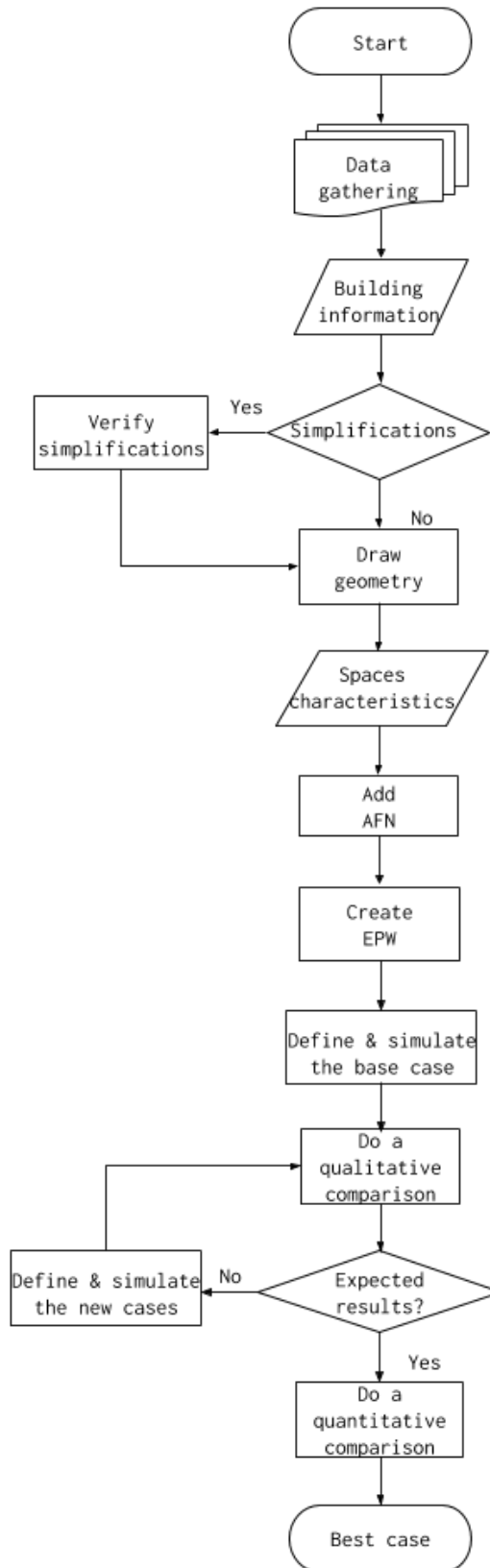
The data gathering includes the building information, the characteristics of all the spaces and the experimental measurements. The characteristics of the spaces can be collected once the building is defined, but the information could change throughout the simulations, so it is recommended to get information until the validation period ends. Experimental measurements should be collected before and after the validation period to have more experimental data that can be compared with the simulations. If simplifications are needed, these should be made and verified to simulate the real conditions of the building, not changing its characteristics. When drawing the geometry, it is recommended to save a different version of each change and simulate it. This suggestion is to have a support file that can help if there is any failure in the simulation and to do not have to draw the geometry from the beginning. The spaces characteristics should be added to simulate the real conditions of the spaces. The Airflow network is used to add natural ventilation and infiltration into the spaces, this information can be taken from the literature, but in the following steps, some coefficients could be changed to have a better comparison with the experimental data. When the EPW is



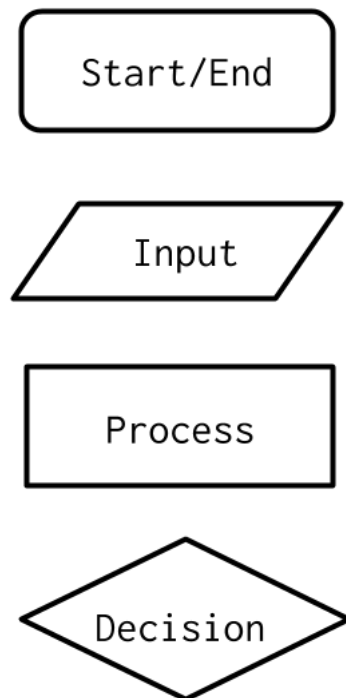
### C. METHODOLOGY FLUX DIAGRAM

---

created, it is recommended to verify the weather file with a simulation, and the simulated data should be overlap with the input weather information. In the base case, all features that are definitive and cannot change should be included. When the qualitative comparison between measured and simulated data have resulted not expected, new cases should be defined and simulated with control variables that can change, such as natural ventilation, infiltration and internal gains by electric equipment, people or lights. After the qualitative comparison between measured and simulated information is made, and it is close to each other, a quantitative comparison with metrics should be performed. To select the best case, the case must have the best values in most metrics.



**Figure C.1:** Methodology flux diagram.



**Figure C.2:** Flowchart symbols.

# Bibliography

---

- [1] UNECE. Energy Efficiency in Buildings - Sustainable Energy - UNECE. Technical report, 2018. 1
- [2] International energy Agency. Building Energy Performance Metrics Secure Sustainable Together Supporting Energy Efficiency Progress in Major Economies BUILDING ENERGY EFFICIENCY AND SKGROUP. Technical report. 1
- [3] CONUEE. Informe nacional de monitoreo de la eficiencia energética de México. Technical report, CONUEE. 1, 2, 4
- [4] International Energy Agency. Technology Roadmap Energy Efficient Building Envelopes. Technical report, 2018. 1
- [5] CONUEE. NOM-020-ENER, Guía de cálculo. Technical report, 2017. [https://www.conuee.gob.mx/transparencia/GuiaHerramientaCalculoNOM\\_020\\_V1.00.pdf](https://www.conuee.gob.mx/transparencia/GuiaHerramientaCalculoNOM_020_V1.00.pdf). 2, 3
- [6] SENER. NOM-008-ENER-2001. DOF - Diario Oficial de la Federación. 2
- [7] SENER. NOM-020-ENER-2011. DOF - Diario Oficial de la Federación. 2

## BIBLIOGRAPHY

---

- [8] G. Huelzs, G. Barrios, and J. Rojas. Importancia del análisis de transferencia de calor dependiente del tiempo en la evaluación del desempeño térmico de la envolvente de una edificación. *Estudios de arquitectura bioclimatica*, IX. 3
- [9] DOE. Building Energy Modeling 101: Architectural Design Use Case — Department of Energy. <https://www.energy.gov/eere/buildings/articles/building-energy-modeling-101-architectural-design-use-case>. 3
- [10] International Council for Research, Innovation in Building, Nuno M. Construction., Armando Pinto, and Guilherme Carrilho da Graça. *Energy and buildings.*, volume 75. Elsevier Sequoia S.A, 1977. 3
- [11] Tianzhen Hong, Jared Langevin, and Kaiyu Sun. Building simulation: Ten challenges. *Building Simulation*, 11(5):871–898, 10 2018. 4
- [12] Verónica Calixto. Methodology for the validation of thermal simulations of a real building, 2019. 4, 36
- [13] NREL, ANL, LBNL, ORNL, and PNN. OpenStudio — Department of Energy, 2010. 6
- [14] UnmetHours. What are the cause and implications of the warning of too many figures in a shadow overlap., 2017. <https://unmethours.com/question/27822/what-are-the-causes-and-implications-of-the-warning-too-many-figures-15000-in-a-14>
- [15] Kayako Help Desk Software. Too many figures in a shadow overlap, 2015. <http://energyplus.helpserve.com/knowledgebase/article/View/70/17/too-many-figures-in-a-shadow-overlap>. 14

- [16] LBNL. Output: Input Output Reference — EnergyPlus 8.9, 2018. 19
- [17] LBNL. Engineering Reference. Technical report, 2018. 19
- [18] UAT IER-UNAM, UNISON and UC. Ener-Habitat, 2014. <https://www.enerhabitat.unam.mx>. 20
- [19] Farhang Tahmasebi and A Mahdavi. A two-staged simulation model calibration approach to virtual sensors for building performance data. In *Proceedings of BS 2013: 13th Conference of the International Building Performance Simulation Association*, pages 608–613, 2013. 22
- [20] R. Scherer G. Gudnason. *EWork and eBusiness in architecture, engineering and construction : proceedings of the European Conference on Product and Process Modelling 2012*. 2012. 22
- [21] J I Montero, Pere Muñoz, and Assumpció Antón. Discharge coefficients of greenhouse windows with insect-proof screens. *Acta Horticulturae*, 443:71–78, 1997. 23
- [22] IER-UNAM. ESOLMET, 2010. <http://esolmet.ier.unam.mx/>. 27
- [23] DOE. Consumer Tips to Cut Standby Power » Standby Power. 33